Electronic Thesis and Dissertation Repository

10-10-2018 1:00 PM

The Impact of Free Radical Stabilization Techniques on In Vivo Property Changes in Highly Cross-Linked Polyethylene Acetabular Liners

Michael M. Decker ., *The University of Western Ontario*

Supervisor: Brent Lanting, *The University of Western Ontario*

: Robert Klassen, *The University of Western Ontario*

A thesis submitted in partial fulfillment of the requirements for the Master of Science degree in Surgery

© Michael M. Decker . 2018

Follow this and additional works at: <https://ir.lib.uwo.ca/etd>

 Part of the [Orthopedics Commons](#)

Recommended Citation

Decker, Michael M. ., "The Impact of Free Radical Stabilization Techniques on In Vivo Property Changes in Highly Cross-Linked Polyethylene Acetabular Liners" (2018). *Electronic Thesis and Dissertation Repository*. 5769.

<https://ir.lib.uwo.ca/etd/5769>

This Dissertation/Thesis is brought to you for free and open access by Scholarship@Western. It has been accepted for inclusion in Electronic Thesis and Dissertation Repository by an authorized administrator of Scholarship@Western. For more information, please contact wlsadmin@uwo.ca.

Abstract

Highly cross-linked polyethylene (HXLPE) was introduced into total hip arthroplasty (THA) to reduce long-term wear-related complications. However, HXLPE production and *in vivo* oxidation can alter mechanical behavior. Mechanical failure of HXLPE liners at the implant rim have been reported. The purpose of this thesis is to determine if thermal free radical stabilization techniques used in HXLPE production alter the mechanical properties, physical properties and oxidative stability of liner rims after extended *in vivo* time.

Retrieved remelted, single annealed and sequentially annealed HXLPE liner rims were mechanically tested using a validated microindentation technique. Oxidation and crystalline phase composition were measured. Results demonstrated remelted liner rims had a decrease in mechanical properties but were oxidatively stable, whereas single and sequentially annealed liners demonstrated oxidation and increased crystallinity despite stable mechanical properties. This suggests mechanical properties change *in vivo* for certain implants, but this is not due to *in vivo* oxidation or altered crystallinity.

Keywords

Total hip arthroplasty, ultra-high molecular weight polyethylene, highly cross-linked polyethylene, depth sensing indentation, microindentation, Raman spectroscopy, oxidation index, crystallinity, mechanical properties, acetabular rim fracture

Co-Authorship Statement

Chapter 1

- Michael Decker – Author
- Brent Lanting – Assistance with manuscript preparation

Chapter 2

- Michael Decker – Author
- Brent Lanting – Assistance with manuscript preparation

Chapter 3

- Michael Decker – Author

Chapter 4

- Michael Decker – Author
- Brent Lanting – Assistance with manuscript preparation

Chapter 5

- Michael Decker – Author, study design, data analysis and interpretation
- Brent Lanting – Assistance with manuscript preparation, study design and data interpretation
- Matthew Teeter – Assistance with manuscript preparation and data interpretation
- Robert Klassen – Assistance with sample testing and data interpretation
- Aria Khalili – Sample testing, assistance with study design

Chapter 6

- Michael Decker – Author, study design, data analysis and interpretation
- Brent Lanting – Assistance with manuscript preparation, study design and data interpretation

- Mary Jane Walzak – Sample preparation, sample testing, assistance with data interpretation and study design
- Matthew Teeter – Assistance with manuscript preparation and data interpretation
- Robert Klassen – Assistance with manuscript preparation, sample testing and data interpretation
- Aria Khalili – Sample testing, assistance with study design

Chapter 7

- Michael Decker – Author
- Brent Lanting – Assistance with manuscript preparation

Acknowledgments

There are a number of people who should be acknowledged for the role they played in the completion of this thesis. I have been extremely fortunate to be surrounded by a supportive and knowledgeable team. To Dr. Lanting, I cannot thank you enough for your support and encouragement not only in this work but throughout fellowship. You have always made yourself available and willing to provide guidance. You've provided me support in my professional and personal life and I am fortunate to call you a mentor. To Dr. Teeter, thank you for your support in navigating and accessing the retrieval laboratory as well as your assistance in interpreting and presenting the data for this project. To Dr. Klassen, thank you for providing me access to your laboratory and staff for our mechanical testing and your thoughtful input in our data interpretation. To Aria Khalili, thank you for all of your hard work throughout the year in getting mechanical testing completed. To Mary Jane Walzak, thank you for all of your work through Surface Science Western. Your help in sample preparation, testing, study design and interpretation of our results cannot be understated. You have helped me obtain an understanding of material testing that I hope to continue to expand. To Bryn Zomar, thank you for your help in getting appropriate ethics approvals and your support. To Lyndsay Somerville, thank you for your support as well as your assistance in obtaining the textbook I needed to build knowledge on this subject. You have all been essential to this thesis and I cannot thank you enough.

I would like to thank all of the consultants in the Arthroplasty division for their time, patience, and dedication to my training. My year here was unforgettable and I thank you all for allowing me to be a part of this fellowship. Your contributions to the implant retrieval laboratory allowed me to complete this work, and I thank you for that as well.

To my wife Lauren and my children Audrey and Olivia, this year of fellowship and writing this thesis would never be possible without your support. And to my mother Deborah and father Dale, thank you for the support you provided my family during the last year. We could not be where we are today without you.

Table of Contents

Abstract.....	i
Co-Authorship Statement.....	ii
Acknowledgments.....	iv
Table of Contents.....	v
List of Abbreviations.....	ix
List of Tables.....	xi
List of Figures.....	xii
List of Appendices.....	xvii
Chapter 1.....	1
1 Total Hip Arthroplasty: An Introduction.....	1
1.1 Anatomy and Biomechanics of the Hip Joint.....	1
1.2 Hip Arthritis and Treatment Options.....	3
1.3 Total Hip Arthroplasty.....	4
1.3.1 Implant Design.....	4
1.3.2 Implant Fixation.....	6
1.3.3 Implant Positioning.....	7
1.3.4 Implant Longevity.....	10
1.4 Research Objectives.....	12
1.5 References.....	13
Chapter 2.....	19
2 Highly Cross-Linked Polyethylene: The Impact of Free Radical Stabilization on Implant Properties.....	19
2.1 Introduction.....	19
2.2 UHMWPE and the Development of HXLPE.....	20

2.3	The Impact of Radiation Cross-Linking and Thermal Stabilization on HXLPE Properties	23
2.4	The Impact of Oxidation on First Generation HXLPE Acetabular Liners	24
2.4.1	Oxidation and Mechanical Properties of HXLPE Acetabular Liners in Experimental Models	24
2.4.2	Oxidation and Mechanical Properties of Retrieved Annealed HXLPE Acetabular Liners	26
2.4.3	Oxidation and Mechanical Properties of Retrieved Remelted HXLPE Acetabular Liners	27
2.4.4	Mechanical Failure of First Generation HXLPE Acetabular Liners	29
2.5	Second Generation HXLPE: Sequential Annealing and Antioxidant Stabilization	33
2.5.1	Sequentially Annealed HXLPE	33
2.5.2	Antioxidant Stabilized HXLPE.....	35
2.6	Conclusions.....	36
2.7	References.....	36
Chapter 3	43
3	Thesis Outline and Summary.....	43
Chapter 4	45
4	Methodology for the Assessment of Physical and Mechanical Properties of Highly Cross-Linked Polyethylene	45
4.1	Indentation Testing	46
4.2	Assessment of Oxidation	49
4.3	Assessment of Crystallinity	52
4.4	Summary.....	54
4.5	References.....	55
Chapter 5	62

5	A Comparison of Hardness Changes Between Retrieved Highly Cross-Linked Polyethylene Bearings with Different Free Radical Stabilization Techniques	62
5.1	Introduction.....	62
5.2	Materials and Methods.....	64
5.3	Results.....	67
5.4	Discussion.....	71
5.5	References.....	74
Chapter 6.....		79
6	Effects of Free Radical Stabilization on Changes in Mechanical and Structural Properties of Retrieved Highly Cross-Linked Polyethylene Acetabular Liners	79
6.1	Introduction.....	79
6.2	Materials and Methods.....	81
6.2.1	Implant Selection	81
6.2.2	Microindentation Testing.....	82
6.2.3	Sample Preparation and Fourier Transform Infrared Spectroscopy Analysis.....	83
6.2.4	Raman Spectroscopy Analysis.....	84
6.2.5	Scanning Electron Microscopy	85
6.2.6	Statistical Analysis.....	86
6.3	Results.....	86
6.4	Discussion.....	93
6.5	References.....	97
Chapter 7.....		103
7	Discussion	103
7.1	Discussion and Conclusions	103
7.2	Future Directions	106

7.3 References.....	106
Appendix A - Patient Data for Retrieved HXLPE Liners (Chapter 5)	111
Appendix B - Patient Data for Retrieved HXLPE Liners (Chapter 6)	114
Appendix C – Ethics Approvals	115
Appendix D – Permissions for Tables and Figures	118
Curriculum Vitae	130

List of Abbreviations

ASTM – American Society for Testing and Materials

C – Celsius

cm – Centimeter

CoCr – Cobalt Chromium

DOI – Dartmouth oxidation index

DSI – Depth-sensing indentation

F – Force

FTIR – Fourier transform infrared spectroscopy

g – Gram

gf – Gram-force

HV – Vickers hardness

HXLPE – Highly cross-linked polyethylene

IR – Infrared

IRL – Implant retrieval laboratory

ISO – International Organization for Standardization

keV – thousand electronvolt

kgf – kilogram-force

kGy – Kilogray

mm – Millimeter

NIH – National Institute of Health

nm – Nanometer

OI – Oxidation Index

SEM – Scanning electron microscopy

THA – Total hip arthroplasty

TVI – Transvinylene index

UHMWPE – Ultra-high molecular weight polyethylene

μm – Micrometer

List of Tables

Table 5-1 - Summary of retrieval and control implant data.....	66
Table 5-2 - <i>In vivo</i> and <i>Ex vivo</i> Times (years) by thermal stabilization	67
Table 5-3 - Correlation between Vickers Hardness (HV), <i>in vivo</i> and <i>ex vivo</i> time.....	68
Table 6-1 - Summary of retrieval and control implant data.....	82
Table 6-2 - <i>In vivo</i> and <i>ex vivo</i> times (years) for each thermal stabilization group	86
Table 6-3 - Vickers Hardness, oxidation, and crystalline phase percentage data from retrieved and control liner rims for each thermal stabilization group.....	91
Table 6-4 - Vickers Hardness, oxidation, and crystalline phase percentage data from remelted retrieved and control liner rims based for samples with and without detectible levels of oxidation.....	92
Table 6-5 - Vickers Hardness, oxidation, and crystalline phase percentage data from sequentially annealed retrieved and control liner rims based on extent of oxidation	93

List of Figures

- Figure 1-1 - Extrapelvic (A) and intrapelvic (B) schematic views of the anterior and posterior columns of the pelvis. (Permissions from Callaghan JJ, Rosenberg AG, Rubash HE, Clohisy J, Beaulé P, DellaValle C. The Adult Hip: Hip Arthroplasty Surgery. Wolters Kluwer Health)..... 1
- Figure 1-2 - Anterior (A) and posterior (B) views of the ligaments comprising the hip joint capsule (permissions from Callaghan JJ, Rosenberg AG, Rubash HE, Clohisy J, Beaulé P, DellaValle C. The Adult Hip: Hip Arthroplasty Surgery. Wolters Kluwer Health; 2015) 2
- Figure 1-3 - Free body diagram of the joint reactive force (JRF) in the hip created by the combined forces of body weight (W) and abductor force (Ab). (from Mirza SB, Dunlop DG, Panesar SS, Naqvi SG, Gangoo S, Salih S. Basic science considerations in primary total hip replacement arthroplasty. Open Orthop J 2010, doi: 10.2174/1874325001004010169) 3
- Figure 1-4 - The components of a common THA design, in this case a metal femoral head articulating on a modular polyethylene acetabular liner (Permissions from Total Hip Arthroplasty (THA). OrthopaedicsOne Clerkship. In: OrthopaedicsOne - The Orthopaedic Knowledge Network. Created Dec 13, 2010 21:12. Last modified Dec 14, 2010 09:10 ver.3. Retrieved 2018-06-17, from <https://www.orthopaedicsone.com/x/-oDYAg>)..... 5
- Figure 1-5 - Examples of different methods of fixation in THA, including fully cementless (A), fully cemented (B), hybrid fixation (C) and reverse hybrid fixation (D). Note that the blue regions represent bone cement. (permissions from Pivec R, Johnson AJ, Mears SC, Mont MA. Hip arthroplasty. Lancet Lond Engl. 2012;380(9855):1768-1777. doi:10.1016/S0140-6736(12)60607-2) 7
- Figure 1-6 - Increasing the head-to-neck ratio increases the impingement free range of motion in THA constructs (permissions from Malik A, Maheshwari A, Dorr LD.

Impingement with total hip replacement. J Bone Joint Surg Am. 2007;89(8):1832-1842. doi:10.2106/JBJS.F.01313).....	9
Figure 1-7 - As femoral head diameter increased, the distance the femoral head must travel to dislocate, or the “jump distance” increases. (Permission from Cho YJ, Nam DC, Jung K. Arthroplasty in Femoral Head Osteonecrosis. Hip Pelvis. 2014;26(2): 65-73. doi:10.5371/hp.2014.26.2.65).....	9
Figure 1-8 - Example of a failed HXLPE acetabular liner at the rim of the implant (permissions from Tower SS. Rim Cracking of the Cross-Linked Longevity Polyethylene Acetabular Liner After Total Hip Arthroplasty. J Bone Joint Surg Am. 2007;89(10):2212. doi:10.2106/JBJS.F.00758).....	11
Figure 2-1 - Representation of the three major phases of UHMWPE: Crystalline phase, amorphous phase, and the third interphase. (Permission from Pezzotti G. Raman spectroscopy of biomedical polyethylenes. Acta Biomater. 2017 Jun 1;55:28–99. DOI: 10.1016/j.actbio.2017.03.015)	21
Figure 2-2 - Bolland’s cycle demonstrating the oxidation of hydrocarbons such as polyethylene (Permission from Costa L, Bracco P. Mechanisms of Cross-Linking, Oxidative Degradation, and Stabilization of UHMWPE. In: Kurtz SM, editor. UHMWPE Biomaterials Handbook (Third Edition), Oxford: William Andrew Publishing; 2016 [p. 467–87.)	22
Figure 2-3 - Accelerated aging of retrieved HXLPE liners with various free radical stabilization techniques demonstrates loss of oxidative stability in both remelted and annealed liners. (Permissions from Rowell SL, Reyes CR, Malchau H, Muratoglu OK. <i>In vivo</i> Oxidative Stability Changes of Highly Cross-Linked Polyethylene Bearings: An <i>Ex vivo</i> Investigation. J Arthroplasty. 2015;30(10):1828-1834. doi:10.1016/j.arth.2015.05.006).....	29
Figure 2-4 - Example of a retrieved fractured remelted HXLPE liner at the implant rim. (Permissions from Moore KD, Beck PR, Petersen DW, Cuckler JM, Lemons JE,	

Eberhardt AW. Early Failure of a Cross-Linked Polyethylene Acetabular Liner: A Case Report. *J Bone Joint Surg Am.* 2008;90(11):2499-2504. doi:10.2106/JBJS.G.01304) ... 31

Figure 2-5 - Example of a retrieved fractured annealed HXLPE liner at the implant rim. (Permissions from Hara D, Nakashima Y, Yamamoto T, *et al.* Late failure of annealed highly cross-linked polyethylene acetabular liner. *J Mech Behav Biomed Mater.* 2013;28:206-212. doi:10.1016/j.jmbbm.2013.08.003)..... 32

Figure 4-1 – Vickers Microindentation with a square-based diamond tip indenter. The Indenter is loaded into the sample surface with a predefined loading force and dwell time, leaving a residual surface indentation. The resultant diagonal lengths (d_1 and d_2) can be measured under an optical microscope. (Courtesy TWI Ltd. Hardness Testing Part 1 - Job Knowledge 74, <https://www.twi-global.com/technical-knowledge/job-knowledge/hardness-testing-part-1-074/> (accessed 24 June, 2018)) 48

Figure 4-2 – Schematic diagram of an interferometer configured for Fourier transform infrared spectroscopy (Courtesy Wikimedia Commons Public Domain, <https://commons.wikimedia.org/w/index.php?curid=25333405>, accessed 02 July, 2018) 50

Figure 4-3 – Chemical structure of polyethylene. (Courtesy Wikimedia Commons Public Domain, <https://commons.wikimedia.org/w/index.php?curid=1018160> (accessed 02 July 2018))..... 51

Figure 5-1 - Vickers Microindentation with a square-based diamond tip indenter. The Indenter is loaded into the implant rim surface with a predefined loading force and dwell time, leaving a residual surface indentation. The resultant diagonal lengths (d_1 and d_2) can be measured under an optical microscope. (Courtesy TWI Ltd. Hardness Testing Part 1 - Job Knowledge 74, <https://www.twi-global.com/technical-knowledge/job-knowledge/hardness-testing-part-1-074/>, (accessed 24 June, 2018)) 66

Figure 5-2 - No statistically significant correlation was noted between Vickers hardness and *in vivo* time for remelted HXLPE liner rims. No individual HXLPE group disproportionately impacted the correlation results..... 68

Figure 5-3 – A statistically significant correlation was noted between Vickers hardness and *ex vivo* time for remelted HXLPE liner rims. No individual HXLPE group disproportionately impacted the correlation results. 69

Figure 5-4 - Comparison of hardness values for control and retrieved liner rims grouped according to their thermal stabilization. Note that statistically significant differences were found in Vickers hardness between retrieved remelted liner rims compared to both single and sequentially annealed liner rims, as well as between remelted control and retrieved liner rims. 70

Figure 6-1 - Vickers Microindentation with a square-based diamond tip indenter. The Indenter is loaded into the implant rim surface with a predefined loading force and dwell time, leaving a residual surface indentation. The resultant diagonal lengths (d_1 and d_2) can be measured under an optical microscope. (Courtesy TWI Ltd. Hardness Testing Part 1 - Job Knowledge 74, <https://www.twi-global.com/technical-knowledge/job-knowledge/hardness-testing-part-1-074> (accessed 24 June, 2018)) 83

Figure 6-2 – Representative implant with removed cross section and indication of locations assessed. Note that the blue arrows indicate the location and direction of the FTIR scans performed both at the articular surface and the rim of the removed cross sections. 84

Figure 6-3 - Oxidation Indices of remelted liner rims with detectable oxidation. Note that all remelted control liners and remaining remelted retrieved liners demonstrated $OI < 0.1$ throughout the rim. 87

Figure 6-4 - Oxidation Indices of single annealed retrieved and control liner rims. All samples, including the control liner, had a rim $OI > 0.1$ 88

Figure 6-5 - Oxidation Indices of sequentially annealed liner rims with detectable oxidation. The control liner demonstrated low but detectable oxidation. 89

Figure 6-6 - Representative optical images of oxidized liner rim cross sections. (A) Remelted liner rim with $OI_{max}=1.89$ and *in vivo* time of 7.93 years. (B) Single annealed

liner rim with $OI_{max}=5.57$ and *in vivo* time of 13.4 years. (C) Sequentially annealed liner rim with $OI_{max}=3.96$ and *in vivo* time of 6.79 years 90

Figure 6-7 - SEM image of a sample demonstrating evidence of surface microcracking along the rim in a remelted liner with no detectable oxidation in the middle of the rim.. 93

List of Appendices

Appendix A - Patient Data for Retrieved HXLPE Liners (Chapter 5)	111
Appendix B - Patient Data for Retrieved HXLPE Liners (Chapter 6)	114
Appendix C - Ethics Approvals	115
Appendix D - Permissions for Tables and Figures	118

Chapter 1

1 Total Hip Arthroplasty: An Introduction

1.1 Anatomy and Biomechanics of the Hip Joint

The bony hip joint is a ball and socket type joint comprised of two parts: the head of the femur articulating inside the acetabulum of the bony pelvis. The acetabulum is created by the fusion of the ischium, ilium, and the pubis. The acetabulum is supported by the thick anterior and posterior columns of the pelvis (figure 1-1). These structures are responsible for transmission of forces from the trunk to the lower extremities through the hip joint (1). The acetabulum is hemispherical with an equatorial axis angled approximately 45 degrees abducted in the coronal plane and 15 degrees anteverted in the sagittal plane (2), and provides nearly circumferential coverage of the femoral head. This amount of coverage supports a substantial range of motion, while maintaining joint stability.

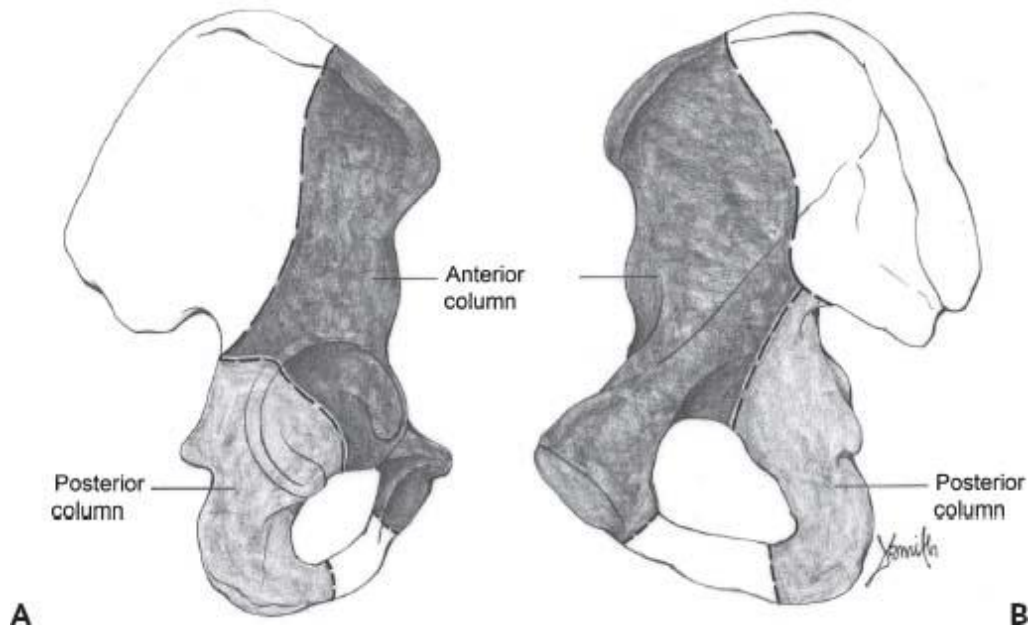

Figure 1-1 - Extrapelvic (A) and intrapelvic (B) schematic views of the anterior and posterior columns of the pelvis. (Permissions from Callaghan JJ, Rosenberg AG,

Rubash HE, Clohisy J, Beaulé P, DellaValle C. The Adult Hip: Hip Arthroplasty Surgery. Wolters Kluwer Health)

Though the hip joint is highly congruent, it relies on other anatomic structures to increase joint stability. The acetabular labrum and joint capsule act as static stabilizers of the joint. The labrum lies on the outer acetabular rim circumferentially, deepening the femoroacetabular articulation and increasing joint congruence. The hip joint capsule attaches to the acetabulum on the outside of the labrum and to the femur along the intertrochanteric ridge, and is comprised of the iliofemoral, pubofemoral, and ischiofemoral ligaments (figure 1-2).

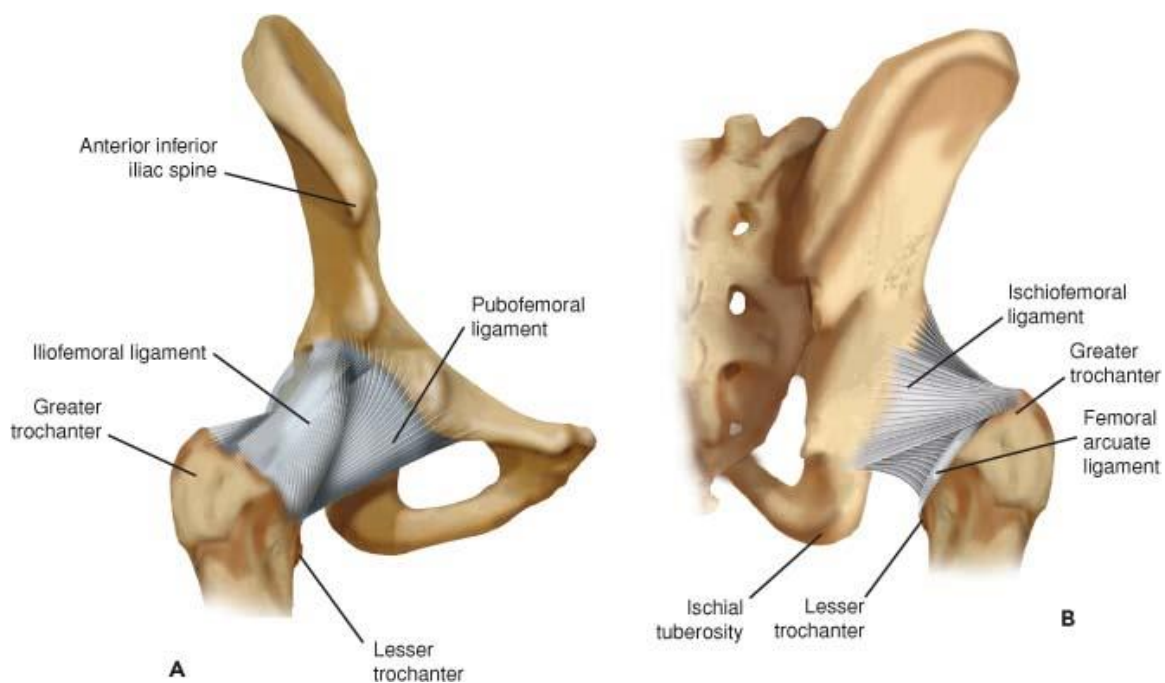

Figure 1-2 - Anterior (A) and posterior (B) views of the ligaments comprising the hip joint capsule (permissions from Callaghan JJ, Rosenberg AG, Rubash HE, Clohisy J, Beaulé P, DellaValle C. The Adult Hip: Hip Arthroplasty Surgery. Wolters Kluwer Health; 2015)

The hip joint is surrounded by numerous muscles that act to dynamically stabilize the joint through a large range of motion. The hip abductors (gluteus medius and gluteus minimus) play a particularly important role in hip biomechanics. During single leg

stance, the hip abductors must generate a force 2.5 times the body weight to counter the force of gravity and maintain a level pelvis. The summed forces of body weight and the hip abductors creates a resultant joint reactive force in the hip joint, which is approximately 3 times body weight during single leg stance and may be as high as 10 times body weight when lifting, running, or jumping (3) (figure 1-3). As the body's center of gravity is posterior to the axis of the hip joint in the sagittal plane, forces placed on the joint from a position of hip flexion can lead to posteriorly directed force creating torsion on the proximal femur that can be as high as 0.9 times body weight (3).

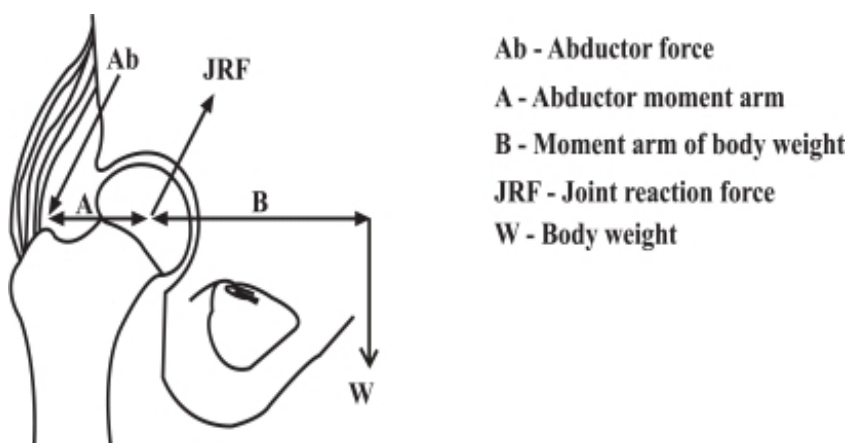

Figure 1-3 - Free body diagram of the joint reactive force (JRF) in the hip created by the combined forces of body weight (W) and abductor force (Ab). (from Mirza SB, Dunlop DG, Panesar SS, Naqvi SG, Gangoo S, Salih S. Basic science considerations in primary total hip replacement arthroplasty. Open Orthop J 2010, doi: 10.2174/1874325001004010169)

1.2 Hip Arthritis and Treatment Options

Arthritis is a term used to describe inflammation in a joint. Arthritis of the hip can be the product of a number of pathologic processes including autoimmune diseases, osteonecrosis, infection, hereditary disorders, congenital disorders, and osteoarthritis. Of these, osteoarthritis is the most common cause of arthritis, estimated to affect 27 million people in the United States (4). Osteoarthritis is characterized by the deterioration of articular cartilage and formation of new bone at the joint surfaces (5). Older age is a strong risk factor for development of osteoarthritis, but other risk factors include female

gender, obesity, low bone density, muscle weakness, and joint laxity (6). With no current treatments available to slow, stop or reverse the process of osteoarthritis, medical management focuses on treatment of symptomatic patients with both nonsurgical and surgical modalities. Recent recommendations by the American College of Rheumatology for nonsurgical treatment of symptomatic hip osteoarthritis include participation in cardiovascular and/or resistance based exercises, aquatic exercises, weight loss, participation in self-management programs, manual therapy with supervised exercises, psychosocial interventions, thermal agents, use of walking aids, oral acetaminophen, oral non-steroidal anti-inflammatories, tramadol, and intraarticular corticosteroid injections (7). However, should nonoperative treatment fail to adequately control symptoms and a patient's function is significantly impaired, surgical intervention with total hip arthroplasty (THA) would be indicated (8).

1.3 Total Hip Arthroplasty

The mainstay of surgical treatment for osteoarthritis of the hip is total hip arthroplasty (THA) (9). Although there were prior attempts at design and implantation of THA, it was the low friction THA introduced and refined by Sir John Charnley in the 1960's that revolutionized surgical treatment of symptomatic hip arthritis(10,11). In this technique, a metal femoral stem was fixed into the femoral medullary canal and a high-density polyethylene acetabular cup was fixed into the acetabulum with an acrylic bonding agent. Survivorship analyses have demonstrated excellent long-term results at up to 35 years (11–13). Though the initial indications for THA proposed by Charney were more limited, they have expanded to younger, higher demand patients with improvements in implant design, fixation techniques and surgical techniques. In fact, a 1995 consensus statement published by the National Institute of Health (NIH) in the United States noted that THA was an option for “nearly all patients with diseases of the hip that cause chronic discomfort and significant functional impairment (15).”

1.3.1 Implant Design

THA replaces the abnormal articular surfaces of the proximal femur and acetabulum with artificial bearings fixed to the host bone. On the femoral side, the native femoral head and

a portion of the femoral neck are removed and, after appropriate preparation of the bone, a metallic stem is inserted into the femoral medullary canal. This stem has a neck, on which a spherical femoral head is attached via a conical trunnion and bore press fit taper connection, commonly referred to as a Morse taper. On the acetabular side, the native acetabular cartilage is removed through a reaming process and replaced with either a monobloc polyethylene hemispherical cup or a metallic hemispherical shell, in which a modular bearing surface is attached. Due to the modular capability of modern implants, multiple bearing surfaces are available for THA articulation. These include cobalt chromium (CoCr) or ceramic femoral heads and CoCr, ceramic, and ultra-high molecular weight polyethylene (UHMWPE) acetabular liners. The most commonly utilized THA bearing design is a CoCr femoral head that articulates with an UHMWPE acetabular liner (figure 1-4). This modularity of implants allows for adjustment of various parameters that can restore normal hip biomechanics.

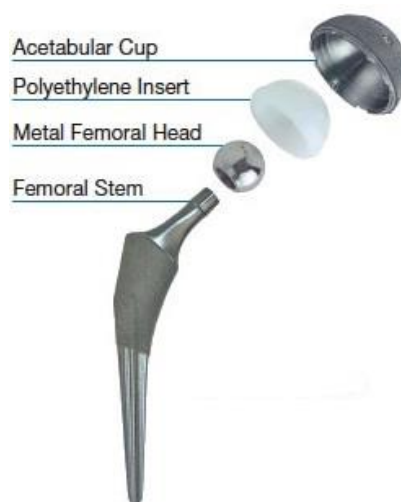

Figure 1-4 - The components of a common THA design, in this case a metal femoral head articulating on a modular polyethylene acetabular liner (Permissions from Total Hip Arthroplasty (THA). OrthopaedicsOne Clerkship. In: OrthopaedicsOne - The Orthopaedic Knowledge Network. Created Dec 13, 2010 21:12. Last modified Dec 14, 2010 09:10 ver.3. Retrieved 2018-06-17, from <https://www.orthopaedicsone.com/x/-oDYAg>)

1.3.2 Implant Fixation

Fixation of THA components can be achieved with either a cemented (Polymethyl methacrylate) or cementless technique (figure 1-5). Modern cement fixation as introduced and studied by Charnley (10,16) relied not on adherence of the acrylic polymer to bone, but rather on the formation of a cast of the inner surface of the bone which would allow distribution of forces from the hip joint evenly over a large surface area. Cementing technique has evolved over time (17) to enhance penetration into cancellous bone and improve density and uniformity of the cement mantle. These modern cementing techniques include vacuum mixing of cement, sustained pressurization during filling, retrograde canal filling, debridement of the endosteal bone with pulse lavage, use of a distal canal plug, and centralizers. Fixation with modern cementing techniques has demonstrated excellent survivorship (18) and remains an ideal fixation method in older patients with poorer bone quality. Cementless fixation has become the most commonly used method of implant fixation in THA (19). This technique requires both immediate mechanical stability of the implants within the bone (acetabulum or femoral canal) as well as intimate contact between the implant surface and the bone. If stability is achieved with implant displacement relative to the bony surface less than 150 μm , long term biologic fixation can occur between the implant and host bone, with greater motion leading to fibrous connective tissue growth without osseous integration with the implant (20). Implants with porous coating induce a bony ingrowth into the metal surface pores on the implant surface, whereas plasma spray or grit blasted implants allow for bony ongrowth on the implant surface. This fixation technique is preferred in younger patients with bone quality suitable for biologic ingrowth or ongrowth, as this may impart a more sustainable fixation interface compared to cemented techniques in this patient population.

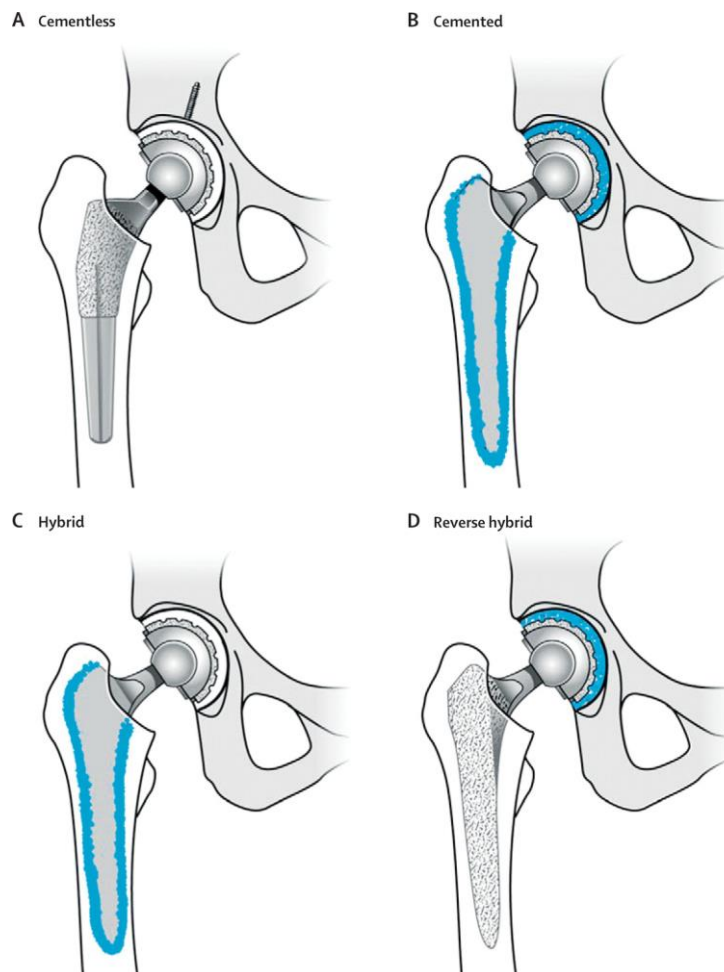

Figure 1-5 - Examples of different methods of fixation in THA, including fully cementless (A), fully cemented (B), hybrid fixation (C) and reverse hybrid fixation (D). Note that the blue regions represent bone cement. (permissions from Pivec R, Johnson AJ, Mears SC, Mont MA. Hip arthroplasty. Lancet Lond Engl. 2012;380(9855):1768-1777. doi:10.1016/S0140-6736(12)60607-2)

1.3.3 Implant Positioning

Proper implant position is essential to restore normal hip biomechanics, reduce the risk of complications and improve survivorship in THA. The goals of proper implant position are to restore leg length, femoral offset, and femoral and acetabular version. Alterations of these parameters are predominantly achieved by proper femoral stem and acetabular component placement. However, they can also be changed through the modular

components of a THA, specifically the length and size of the modular femoral head bearing or the size, offset, or version of the modular acetabular bearing surface.

On the femoral side, the major parameters to consider in implant placement and design are length, offset, version and head-to-neck ratio. Restoration of leg length is achieved through the depth of insertion of the femoral component, the length of the femoral neck, and the length of the femoral head. Leg length is important for normal gait mechanics. Offset refers to the distance between the center of the femoral head and the long axis of the femoral stem, and is predominantly a product of the stem design. However, if a longer or shorter femoral head is utilized, horizontal offset is increased or decreased, respectively. Restoration of offset and length is essential to properly tension the hip abductors muscles and restore the normal vector of force produced with their contraction. Inadequate restoration of abductor tension can increase the risk of prosthetic dislocation. The native femoral neck is anteverted relative to the distal femoral transepicondylar axis approximately 10-15 degrees (3), and represents ideal neck version for the implanted femoral component. Excessive changes to version, either anteversion or retroversion, can lead to impingement of the femoral neck on the acetabular component during range of motion and lead to prosthetic dislocation. The ratio of the size of the femoral neck to the femoral head has major implications in motion and stability. Though the femoral neck diameter is typically a fixed parameter, the ratio can be altered by changing the size of the modular femoral head. When the head-to-neck diameter ratio is increased, the range of motion allowed prior to impingement of the neck on the acetabular rim is increased (figure 1-6). Furthermore, as femoral head diameter increases, the distance that center of the femoral head must travel to dislocate from the acetabulum (the “jump distance”) is increased (figure 1-7). Both increased femoral head diameter and head-to-neck diameter ratio reduce the risk of prosthetic dislocation.

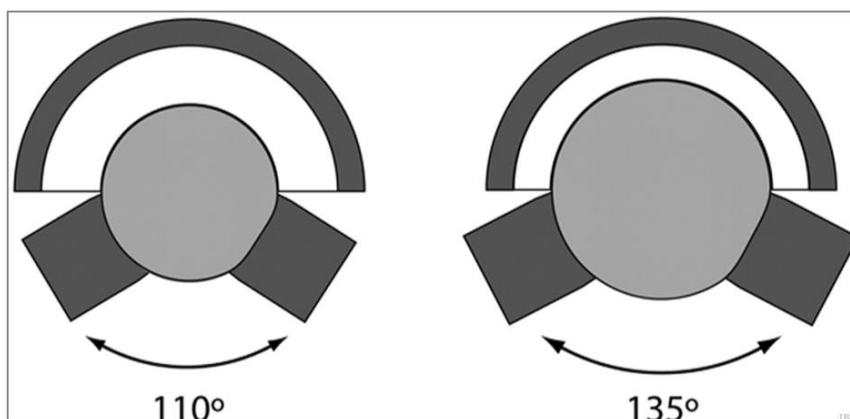

Figure 1-6 - Increasing the head-to-neck ratio increases the impingement free range of motion in THA constructs (permissions from Malik A, Maheshwari A, Dorr LD. Impingement with total hip replacement. J Bone Joint Surg Am. 2007;89(8):1832-1842. doi:10.2106/JBJS.F.01313)

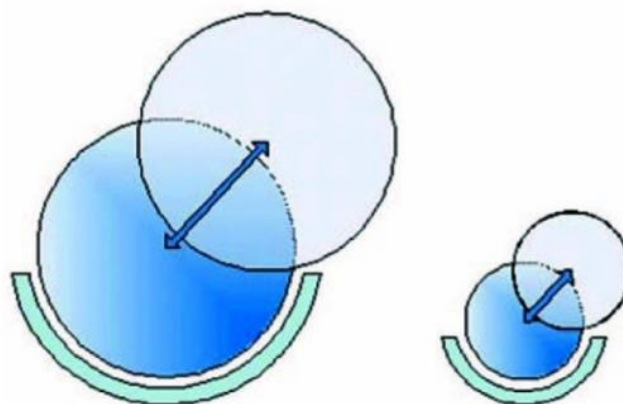

Figure 1-7 - As femoral head diameter increased, the distance the femoral head must travel to dislocate, or the “jump distance” increases. (Permission from Cho YJ, Nam DC, Jung K. Arthroplasty in Femoral Head Osteonecrosis. Hip Pelvis. 2014;26(2): 65-73. doi:10.5371/hp.2014.26.2.65)

On the acetabular side, the major parameters to consider during implantation are the center of rotation, version, and inclination. The center of rotation of the hip should be restored by medial placement of the acetabular component. If the hip center of rotation is lateralized, this has the effect of increasing the lever arm of body weight and an increase in the resultant joint reactive force. Acetabular version and inclination can have an impact

on stability and impingement. Excessive anteversion or retroversion of the acetabulum, much like the femoral component, can lead to neck/acetabulum impingement and prosthetic dislocation. Excessive vertical placement of the acetabular component may lead to increased risk of dislocation, excessive edge loading of the implant and wear (21), whereas excessive horizontal placement can lead to decreased hip flexion and risk of anterior impingement and dislocation (22). However, optimal acetabular implant version and inclination remains controversial, with recommendations ranging from 0°-30° of anteversion and 30°-50° of inclination (22).

Implant position has a major impact on hip joint biomechanics and stability, as noted above, however it also plays a major role in the wear on the polyethylene bearing surface and should be considered when deciding on a THA construct. Increasing femoral head size leads to increased total surface area contact between the femoral head and polyethylene liner, leading to increased volumetric wear (23). Relatively vertical acetabular component positioning can cause the femoral head to articulate with the edge of the polyethylene liner superiorly, increasing contact stress over decreased contact area and increasing wear (24).

1.3.4 Implant Longevity

THA has proven to be an very successful procedure with excellent long term survivorship (25). However, despite improvements in fixation techniques and bearing surfaces, the rate of revision THA has not decreased (26). In the United States, substantial increases in both primary and revision THA procedures are projected, with an estimated 174% increase in primary THA and 137% increase in revision THA by 2030 (27). The most common causes for revision THA are dislocation (17.3%), mechanical loosening (16.8%), mechanical problems (13.4%), infection (12.8%), and osteolysis (5.7%) (28). Although poor implant alignment and fixation have been implicated in mechanical loosening, it is now appreciated that wear of UHMWPE at the articular surface leads to a macrophage-mediated inflammatory cascade that stimulate osteolysis and is a leading cause of implant loosening (26–28) . Highly crosslinked polyethylene (HXLPE) was developed to improve the wear characteristics of acetabular liners (32) and reduce revision surgery related to wear and subsequent osteolysis. When compared to conventional UHMWPE acetabular

liners, HXLPE has proven to be successful in terms of wear and osteolysis (30–37) . However, mechanical properties of the implant are compromised at the expense of improved wear properties, specifically fatigue crack propagation resistance (29,38–40). Irradiation used to create polyethylene cross-linking leads to the formation of free radicals (44). These free radicals can react with oxygen species *in vivo*, leading to polymer chain scission, recrystallization and ultimately increased brittleness (42–46). To stabilize these free radicals, implant manufacturers utilize thermal treatments such as remelting above or annealing below the material melting point. Remelting more effectively removes free radicals at the expense of mechanical properties, where annealing less effectively removes free radicals but maintains mechanical properties (50). Furthermore, certain manufacturers utilize irradiation for implant sterilization, which can reintroduce or increase free radicals in the finished implant. Recent reports of mechanical failure of certain HXLPE acetabular liners at the rim of the implant (51–58) have raised concerns about the possibility of decreased mechanical properties on the longevity of these bearing surfaces (figure 1-8).

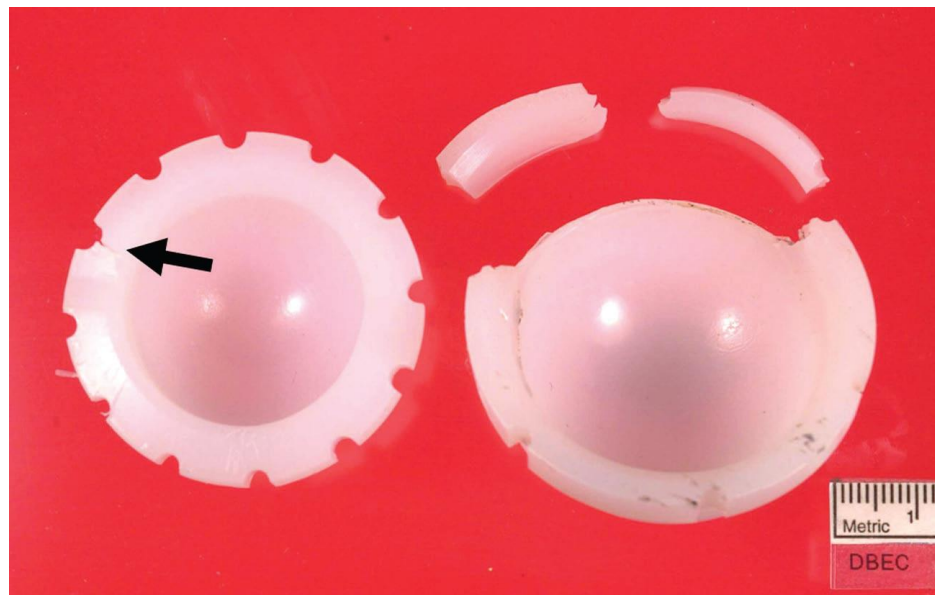

Figure 1-8 - Example of a failed HXLPE acetabular liner at the rim of the implant (permissions from Tower SS. Rim Cracking of the Cross-Linked Longevity Polyethylene Acetabular Liner After Total Hip Arthroplasty. J Bone Joint Surg Am. 2007;89(10):2212. doi:10.2106/JBJS.F.00758)

1.4 Research Objectives

Projections indicate a likely significant increase in the volume of THA procedures being performed in the coming years (27,59,60), driven by both an aging population as well as a shifting threshold for surgery towards younger patients (60). Given the anticipated increase in surgical volume as well as the significant costs and morbidity (26,28,61) associated with revision surgery, improving implant longevity remains imperative.

Although HXLPE has improved polyethylene wear and wear-related revision surgery in THA (30–37), concern exists that *in vivo* oxidation and reduced mechanical properties may create a new clinical problem, supported by reports of catastrophic failure of HXLPE acetabular liners, particularly at the implant rim (51–58). Prior implant retrieval studies have found oxidation of HXLPE acetabular liners at the rim and articular surface as well as degraded mechanical properties of the articular surface (42–45). However, little is known about the mechanical properties of retrieved HXLPE liner rims after *in vivo* exposure. Pilot studies have been performed to validate a non-destructive method of assessing the mechanical properties of retrieved HXLPE acetabular liner rims (62), though the studies were initially limited to a single type of HXLPE liner.

The aim of this masters project is to better understand the role that free radical stabilization processes and *in vivo* oxidation have on the mechanical and physical properties of retrieved HXLPE liner rims after long term *in vivo* use. A previously validated mechanical testing method will be utilized to investigate if *in vivo* changes occur in the mechanical properties of HXLPE liners. Furthermore, physical properties of these liners will be assessed for evidence of oxidation and changes in the microstructure of the HXLPE that may impact their mechanical properties. This combination of testing methods may help in elucidating a possible mechanism of *in vivo* failure of HXLPE acetabular liner rims.

1.5 References

1. Wasielewski RC, Kusuma S, Rosenberg AG. Chapter 2: Gross Anatomy of the Hip. In: *The Adult Hip: Hip Arthroplasty Surgery*. Vol 1. 3rd Edition. Two Commerce Square, 2001 Market Street, Philadelphia, PA 19103: Lippincott Williams & Wilkins; 2016:37-54.
2. Mirza SB, Dunlop DG, Panesar SS, *et al*. Basic science considerations in primary total hip replacement arthroplasty. *Open Orthop J*. 2010;4:169-180. doi:10.2174/1874325001004010169
3. Canale ST, Beaty J. *Campbell's Operative Orthopaedics*. Vol 1. 12th Edition. Philadelphia, PA: Elsevier Mosby
4. Felson DT. Chapter 43. Osteoarthritis. In: Imboden JB, Hellmann DB, Stone JH, eds. *CURRENT Diagnosis & Treatment: Rheumatology*. 3rd ed. New York, NY: The McGraw-Hill Companies; 2013.
5. Johnston Hough Jr. A. Chapter 108: Pathology of Osteoarthritis. In: *Arthritis & Allied Conditions*. 15th Edition. 530 Walnut Street, Philadelphia, PA 19106 USA LWW.com: Lippincott Williams & Wilkins; 2005:2169-2197.
6. Zhang Y, Jordan JM. Epidemiology of osteoarthritis. *Clin Geriatr Med*. 2010;26(3):355-369. doi:10.1016/j.cger.2010.03.001
7. Hochberg MC, Altman RD, April KT, *et al*. American College of Rheumatology 2012 recommendations for the use of nonpharmacologic and pharmacologic therapies in osteoarthritis of the hand, hip, and knee. *Arthritis Care Res*. 2012;64(4):465-474. doi:10.1002/acr.21596
8. Harris WH, Sledge CB. Total hip and total knee replacement (1). *N Engl J Med*. 1990;323(11):725-731. doi:10.1056/NEJM199009133231106
9. Learmonth ID, Young C, Rorabeck C. The operation of the century: total hip replacement. *The Lancet*. 2007;370(9597):1508-1519. doi:10.1016/S0140-6736(07)60457-7
10. Charnley J. Arthroplasty of the hip. A new operation. *Lancet Lond Engl*. 1961;1(7187):1129-1132.
11. Charnley J. The Long-Term Results of Low-Friction Arthroplasty of the Hip Performed as a Primary Intervention. *Bone Jt J*. 1972;54-B(1):61-76.
12. Caton J, Prudhon JL. Over 25 years survival after Charnley's total hip arthroplasty. *Int Orthop*. 2011;35(2):185-188. doi:10.1007/s00264-010-1197-z

13. Callaghan JJ, Bracha P, Liu SS, *et al.* Survivorship of a Charnley total hip arthroplasty. A concise follow-up, at a minimum of thirty-five years, of previous reports. *J Bone Joint Surg Am.* 2009;91(11):2617-2621. doi:10.2106/JBJS.H.01201
14. Berry DJ, Harmsen WS, Cabanela ME, *et al.* Twenty-five-year survivorship of two thousand consecutive primary charnley total hip replacements: Factors affecting survivorship of acetabular and femoral components. *J Bone Joint Surg Am.* 2002 Feb;84-A(2):171-7.
15. NIH consensus conference: Total hip replacement. NIH Consensus Development Panel on Total Hip Replacement. *JAMA.* 1995;273(24):1950-1956.
16. Charnley J. The Bonding of Prostheses to Bone by Cement. *J Bone Joint Surg Br.* 1964;46:518-529.
17. August 1, 2005. The Evolution of Contemporary Cementation Techniques. <https://www.healio.com/orthopedics/hip/news/online/%7B03cc1461-32e7-46b6-a282-cadd462d0264%7D/the-evolution-of-contemporary-cementation-techniques>. Accessed November 5, 2017.
18. Junnila M, Laaksonen I, Eskelinen A, *et al.* Implant survival of the most common cemented total hip devices from the Nordic Arthroplasty Register Association database. *Acta Orthop.* 2016;87(6):546-553. doi:10.1080/17453674.2016.1222804
19. Troelsen A, Malchau E, Sillesen N, *et al.* A review of current fixation use and registry outcomes in total hip arthroplasty: the uncemented paradox. *Clin Orthop.* 2013;471(7):2052-2059. doi:10.1007/s11999-013-2941-7
20. Kienapfel H, Sprey C, Wilke A, *et al.* Implant fixation by bone ingrowth. *J Arthroplasty.* 1999;14(3):355-368.
21. Schmalzried TP, Guttman D, Grecula M, *et al.* The relationship between the design, position, and articular wear of acetabular components inserted without cement and the development of pelvic osteolysis. *J Bone Joint Surg Am.* 1994;76(5):677-688.
22. Widmer K-H, Zurfluh B. Compliant positioning of total hip components for optimal range of motion. *J Orthop Res Off Publ Orthop Res Soc.* 2004;22(4):815-821. doi:10.1016/j.orthres.2003.11.001
23. Elfick AP, Hall RM, Pinder IM, Unsworth A. Wear in retrieved acetabular components: effect of femoral head radius and patient parameters. *J Arthroplasty.* 1998;13(3):291-295.
24. Patil S, Bergula A, Chen PC, *et al.* Polyethylene wear and acetabular component orientation. *J Bone Joint Surg Am.* 2003;85-A Suppl 4:56-63.

25. Clarke A, Pulikottil-Jacob R, Grove A, *et al.* *Joint Registries*. NIHR Journals Library; 2015. <https://www.ncbi.nlm.nih.gov/books/NBK273990/>. Accessed November 5, 2017.
26. Bozic KJ, Kurtz SM, Lau E, *et al.* The epidemiology of revision total hip arthroplasty in the United States. *J Bone Joint Surg Am.* 2009;91(1):128-133. doi:10.2106/JBJS.H.00155
27. Kurtz S, Ong K, Lau E, *et al.* Projections of primary and revision hip and knee arthroplasty in the United States from 2005 to 2030. *J Bone Joint Surg Am.* 89(4):780-785. doi:10.2106/JBJS.F.00222
28. Gwam CU, Mistry JB, Mohamed NS, *et al.* Current Epidemiology of Revision Total Hip Arthroplasty in the United States: National Inpatient Sample 2009 to 2013. *J Arthroplasty.* 2017;32(7):2088-2092. doi:10.1016/j.arth.2017.02.046
29. Willert HG, Bertram H, Buchhorn GH. Osteolysis in alloarthroplasty of the hip. The role of ultra-high molecular weight polyethylene wear particles. *Clin Orthop.* 1990;(258):95-107.
30. Cooper RA, McAllister CM, Borden LS, *et al.* Polyethylene debris-induced osteolysis and loosening in uncemented total hip arthroplasty. A cause of late failure. *J Arthroplasty.* 1992;7(3):285-290.
31. Ingham E, Fisher J. Biological reactions to wear debris in total joint replacement. *Proc Inst Mech Eng [H].* 2000;214(1):21-37. doi:10.1243/0954411001535219
32. McKellop H, Shen F, Lu B, *et al.* Development of an extremely wear-resistant ultra high molecular weight polyethylene for total hip replacements. *J Orthop Res.* 1999;17(2):157-167. doi:10.1002/jor.1100170203
33. Paxton EW, Inacio MCS, Namba RS, *et al.* Metal-on-conventional polyethylene total hip arthroplasty bearing surfaces have a higher risk of revision than metal-on-highly crosslinked polyethylene: results from a US registry. *Clin Orthop.* 2015;473(3):1011-1021. doi:10.1007/s11999-014-4105-9
34. Jacobs CA, Christensen CP, Greenwald AS, *et al.* Clinical performance of highly cross-linked polyethylenes in total hip arthroplasty. *J Bone Joint Surg Am.* 2007;89(12):2779-2786. doi:10.2106/JBJS.G.00043
35. Lachiewicz PF, Soileau ES, Martell JM. Wear and Osteolysis of Highly Crosslinked Polyethylene at 10 to 14 Years: The Effect of Femoral Head Size. *Clin Orthop.* 2016;474(2):365-371. doi:10.1007/s11999-015-4319-5
36. Kurtz SM, Gawel HA, Patel JD. History and systematic review of wear and osteolysis outcomes for first-generation highly crosslinked polyethylene. *Clin Orthop.* 2011;469(8):2262-2277. doi:10.1007/s11999-011-1872-4

37. Glyn-Jones S, Thomas GER, Garfield-Roberts P, *et al.* The John Charnley Award: Highly crosslinked polyethylene in total hip arthroplasty decreases long-term wear: a double-blind randomized trial. *Clin Orthop.* 2015;473(2):432-438. doi:10.1007/s11999-014-3735-2
38. Hanna SA, Somerville L, McCalden RW, *et al.* Highly cross-linked polyethylene decreases the rate of revision of total hip arthroplasty compared with conventional polyethylene at 13 years' follow-up. *Bone Jt J.* 2016;98-B(1):28-32. doi:10.1302/0301-620X.98B1.36527
39. Garvin KL, White TC, Dusad A, *et al.* Low wear rates seen in THAs with highly crosslinked polyethylene at 9 to 14 years in patients younger than age 50 years. *Clin Orthop.* 2015;473(12):3829-3835. doi:10.1007/s11999-015-4422-7
40. Mall NA, Nunley RM, Zhu JJ, *et al.* The incidence of acetabular osteolysis in young patients with conventional versus highly crosslinked polyethylene. *Clin Orthop.* 2011;469(2):372-381. doi:10.1007/s11999-010-1518-y
41. Gencur SJ, Rimnac CM, Kurtz SM. Fatigue crack propagation resistance of virgin and highly crosslinked, thermally treated ultra-high molecular weight polyethylene. *Biomaterials.* 2006;27(8):1550-1557. doi:10.1016/j.biomaterials.2005.09.010
42. Ansari F, Ries MD, Pruitt L. Effect of processing, sterilization and crosslinking on UHMWPE fatigue fracture and fatigue wear mechanisms in joint arthroplasty. *J Mech Behav Biomed Mater.* 2016;53:329-340. doi:10.1016/j.jmbbm.2015.08.026
43. Baker DA, Bellare A, Pruitt L. The effects of degree of crosslinking on the fatigue crack initiation and propagation resistance of orthopedic-grade polyethylene. *J Biomed Mater Res A.* 2003;66(1):146-154. doi:10.1002/jbm.a.10606
44. Costa L, Bracco P. 26 - Mechanisms of Cross-Linking, Oxidative Degradation, and Stabilization of UHMWPE. In: Kurtz SM, ed. *UHMWPE Biomaterials Handbook (Third Edition)*. Oxford: William Andrew Publishing; 2016:467-487. doi:10.1016/B978-0-323-35401-1.00026-0
45. Currier BH. Evaluation of Oxidation and Fatigue Damage of Retrieved Crossfire Polyethylene Acetabular Cups. *J Bone Joint Surg Am.* 2007;89(9):2023. doi:10.2106/JBJS.F.00336
46. Wannomae KK, Bhattacharyya S, Freiberg A, *et al.* *In vivo* oxidation of retrieved cross-linked ultra-high-molecular-weight polyethylene acetabular components with residual free radicals. *J Arthroplasty.* 2006;21(7):1005-1011. doi:10.1016/j.arth.2005.07.019
47. Kurtz SM, Hozack WJ, Purtill JJ, *et al.* 2006 Otto Aufranc Award Paper: Significance of *In vivo* Degradation for Polyethylene in Total Hip Arthroplasty: *Clin Orthop.* 2006;453:47-57. doi:10.1097/01.blo.0000246547.18187.0b

48. Kurtz SM, Hozack W, Marcolongo M, *et al.* Degradation of mechanical properties of UHMWPE acetabular liners following long-term implantation. *J Arthroplasty*. 2003;18(Supplement):68-78. doi:10.1016/S0883-5403(03)00292-4
49. Muratoglu OK, Bragdon CR. 15 - Highly Cross-Linked and Melted UHMWPE. In: Kurtz SM, ed. *UHMWPE Biomaterials Handbook (Third Edition)*. Oxford: William Andrew Publishing; 2016:264-273. doi:10.1016/B978-0-323-35401-1.00015-6
50. Manley MT. 16 - Highly Cross-Linked and Annealed UHMWPE. In: Kurtz SM, ed. *UHMWPE Biomaterials Handbook (Third Edition)*. Oxford: William Andrew Publishing; 2016:274-292. doi:10.1016/B978-0-323-35401-1.00016-8
51. Blumenfeld TJ, McKellop HA, Schmalzried TP, *et al.* Fracture of a Cross-Linked Polyethylene Liner. *J Arthroplasty*. 2011;26(4):666.e5-666.e8. doi:10.1016/j.arth.2010.07.009
52. Duffy GP, Wannomae KK, Rowell SL, *et al.* Fracture of a Cross-Linked Polyethylene Liner Due to Impingement. *J Arthroplasty*. 2009;24(1):158.e15-158.e19. doi:10.1016/j.arth.2007.12.020
53. Furmanski J, Anderson M, Bal S, *et al.* Clinical fracture of cross-linked UHMWPE acetabular liners. *Biomaterials*. 2009;30(29):5572-5582. doi:10.1016/j.biomaterials.2009.07.013
54. Hara D, Nakashima Y, Yamamoto T, *et al.* Late failure of annealed highly cross-linked polyethylene acetabular liner. *J Mech Behav Biomed Mater*. 2013;28:206-212. doi:10.1016/j.jmbbm.2013.08.003
55. Moore KD, Beck PR, Petersen DW, *et al.* Early Failure of a Cross-Linked Polyethylene Acetabular Liner: A Case Report. *J Bone Joint Surg Am*. 2008;90(11):2499-2504. doi:10.2106/JBJS.G.01304
56. Tower SS. Rim Cracking of the Cross-Linked Longevity Polyethylene Acetabular Liner After Total Hip Arthroplasty. *J Bone Joint Surg Am*. 2007;89(10):2212. doi:10.2106/JBJS.F.00758
57. Waewsawangwong W, Goodman SB. Unexpected Failure of Highly Cross-Linked Polyethylene Acetabular Liner. *J Arthroplasty*. 2012;27(2):323.e1-323.e4. doi:10.1016/j.arth.2011.04.010
58. Ast MP, John TK, Labbisiere A, Robador N, *et al.* Fractures of a single design of highly cross-linked polyethylene acetabular liners: an analysis of voluntary reports to the United States Food and Drug Administration. *J Arthroplasty*. 2014;29(6):1231-1235. doi:10.1016/j.arth.2013.12.022
59. Birrell F, Johnell O, Silman A. Projecting the need for hip replacement over the next three decades: influence of changing demography and threshold for surgery. *Ann Rheum Dis*. 1999;58(9):569-572.

60. Ravi B, Croxford R, Reichmann WM, *et al.* The changing demographics of total joint arthroplasty recipients in the United States and Ontario from 2001 to 2007. *Best Pract Res Clin Rheumatol.* 2012;26(5):637-647. doi:10.1016/j.berh.2012.07.014
61. Bozic KJ, Kamath AF, Ong K, *et al.* Comparative Epidemiology of Revision Arthroplasty: Failed THA Poses Greater Clinical and Economic Burdens Than Failed TKA. *Clin Orthop.* 2015;473(6):2131-2138. doi:10.1007/s11999-014-4078-8
62. Singh G. Mechanical Properties of Retrieved Highly Cross-linked Polyethylene Acetabular Liners in Total Hip Arthroplasty. 2017. <https://ir.lib.uwo.ca/etd/4667>.

Chapter 2

2 Highly Cross-Linked Polyethylene: The Impact of Free Radical Stabilization on Implant Properties

2.1 Introduction

Total hip arthroplasty (THA) has proven to be an extremely successful surgical procedure in producing significant pain reduction and improved physical function in patients with end stage arthritis of the hip(1). Sir John Charnley was the first to introduced UHMWPE into his low friction THA design in 1962 (2), and it remains the most common bearing surface used in THA today. However, the success of conventional UHMWPE has been limited by the long term material wear, which can lead to instability, osteolysis, aseptic implant loosening and need for revision surgery (3–5). Furthermore, demand for THA in young and active patients has also increased the demand for a more durable bearing surface (6). These factors facilitated the development of highly cross-linked polyethylene (HXLPE) bearing surfaces. Clinical and *in vitro* studies have confirmed a significant reduction in wear rates compared to conventional UHMWPE, along with a significant reduction in osteolysis and wear-related revision surgery rates (7–13).

Cross-linking in UHMWPE is produced when the material is irradiated. Radiation energy leads to bond cleavage in polyethylene chains and development of highly reactive free radicals. In an inert environment, these free radicals combine to create the desired effect of cross-linking. However, if free radicals are exposed to oxygen they can react and create a cyclic, self-perpetuating oxidation cycle that leads to significant material degradation and changes in the mechanical properties of the implant (14).

In order to reduce or eliminate the potential for oxidation and subsequent material degradation, free radical stabilization processes were introduced to HXLPE production. The first generation HXLPE implants underwent thermal stabilization through either post-irradiation remelting or annealing. Remelting allows for complete mobilization of polyethylene chains and elimination of free radicals, however the mechanical properties of the material are decreased. Though annealing better maintains baseline mechanical properties compared to remelted HXLPE, this process does not fully mobilize

polyethylene chains, and though free radicals are significantly reduced they are not completely eliminated. These residual free radicals can be oxidized when exposed to air or oxygen rich joint fluid, leading to mechanical property degradation. Moreover, *in vivo* oxidation of remelted polyethylene has been detected (15–19), leading to the discovery of alternative mechanisms for *in vivo* oxidation in the absence of residual free radicals (15,18,20–24). Second generation HXLPE liners have been introduced with new stabilization processes, including thermal sequential annealing and antioxidant doping, with the aim of improving the balance of wear, mechanical properties, and oxidative stability.

Reports of mechanical failure of first generation HXLPE liners (25–32) along with concerns regarding the oxidative stability and mechanical properties of first and second generation HXLPE implants has led to both experimental testing and retrieval analysis to better understand the behavior of these implants *in vivo*. Here, a review the literature regarding the oxidative stability and mechanical properties of first and second generation HXLPE implants is presented.

2.2 UHMWPE and the Development of HXLPE

UHMWPE is a linear polymer with a molecular weight of at least 3.1 million g/mol (33). UHMWPE is a semi-crystalline material containing three phases: crystalline, amorphous, and interphase (figure 2-1). The crystalline phase is characterized by well organized, densely packed lamellae whereas the amorphous phase is fairly disorganized. In orthopaedic implants, UHMWPE molecular weight typically ranges from 3.5 – 7.5 million g/mol composed of an approximately 50% crystalline phase (34). The crystalline lamellae of UHMWPE are intertwined within the amorphous regions, and the lamellae can connect via short tie molecules. A larger number of these tie molecules are present in UHMWPE compared to lower molecular weight counterparts, imparting a significantly increased wear resistance and toughness (14). The interplay and organization of these phases in UHMWPE impart the desirable characteristics needed in arthroplasty bearing surfaces.

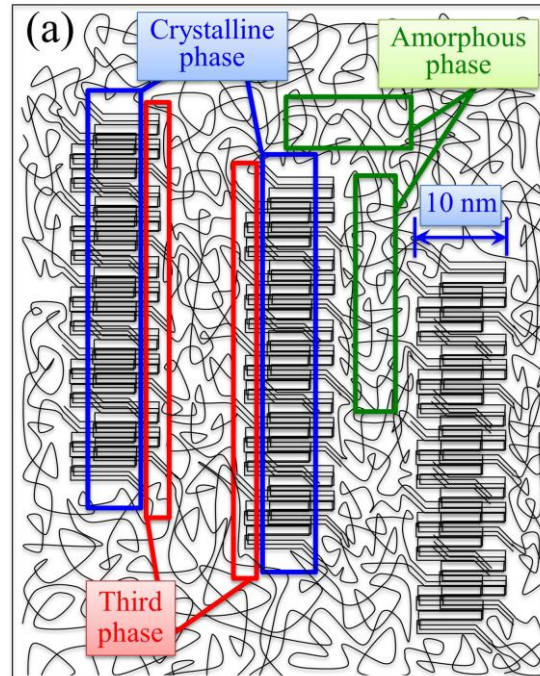

Figure 2-1 - Representation of the three major phases of UHMWPE: Crystalline phase, amorphous phase, and the third interphase. (Permission from Pezzotti G. Raman spectroscopy of biomedical polyethylenes. *Acta Biomater.* 2017 Jun 1;55:28–99. DOI: 10.1016/j.actbio.2017.03.015)

In order to produce medical grade UHMWPE implants, a number of precise manufacturing processes must take place. Ethylene gas is converted to polymer form as a powder or resin using a converter and following ASTM standard F648 and ISO standard 5834-1 (35). The resin is then consolidated by either ram bar extrusion, compression sheet molding, or direct compression molding techniques under elevated temperatures and pressures. The final implant is then fabricated by machining the consolidated material into its final component shape and size. Each of these phases in manufacturing, many of which are proprietary, has the potential to change the chemical and microstructural properties of UHMWPE. Once the final implant has been machined, it requires packaging and sterilization. Up until the 1990's, UHMWPE implants were sterilized using 25-40 kilogray (kGy) of gamma irradiation in the presence of air (36). Studies implicating polyethylene wear particles as a major contributor to osteolysis led to investigations into the role of radiation and air exposure on polyethylene properties.

Radiation sterilization imparts significant energy into polyethylene chains which can lead to the cleavage of C-C and C-H covalent bonds, forming highly reactive free radicals. In an inert environment without other reactive species, free radicals in the amorphous regions can recombine to form cross-links within the polyethylene chains, whereas those formed in the crystalline region remain trapped (20). These remnant free radicals are long living and if are exposed to oxygen can form alkyl free radicals, leading to a self-perpetuating oxidation process known as Bolland's cycle (figure 2-2) (37). This oxidation cycle leads to chain scission and a reduction in the molecular mass of UHMWPE, with a subsequent increased proportion of the crystalline phase (36,38) through the development of thin crystalline lamellae in the amorphous region (14). The end result is an increase in material brittleness, most notably in the subsurface region of the implant 1-2mm below the outer surface. This increased brittleness could potentially increase the risk of fatigue damage (36).

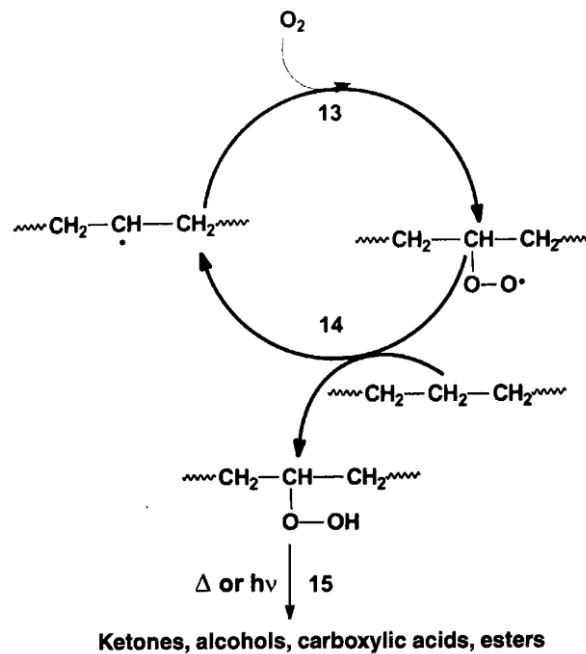

Figure 2-2 - Bolland's cycle demonstrating the oxidation of hydrocarbons such as polyethylene (Permission from Costa L, Bracco P. Mechanisms of Cross-Linking, Oxidative Degradation, and Stabilization of UHMWPE. In: Kurtz SM, editor.

UHMWPE Biomaterials Handbook (Third Edition), Oxford: William Andrew Publishing; 2016 [p. 467–87.)

Prior to this discovery, the oxidative process occurred during implant storage on the shelf prior to implantation due to sterilization of the implant in air and storage in oxygen permeable packaging. Manufacturers transitioned to oxygen barrier packing and sterilization with new methods including gamma irradiation in an inert environment or sterilization in gas plasma or ethylene oxide. It was soon discovered that wear rates in gas plasma and ethylene oxide were nearly twice that of gamma air sterilized implants (39–41) which led to the discovery that radiation induced cross-linking played a significant factor in wear properties. Furthermore, gamma inert sterilized implants retrieved after *in vivo* time continued to demonstrate evidence of oxidative degradation due to residual free radicals and *in vivo* exposure to oxygen (42). These discoveries led to the development of the first generation of highly cross-linked polyethylene implants.

2.3 The Impact of Radiation Cross-Linking and Thermal Stabilization on HXLPE Properties

First generation HXLPE was developed to take advantage of the wear-reducing properties imparted by crosslinking while reducing or eliminating the potential for oxidative degradation and minimize the impact on mechanical properties. Gamma or electron beam radiation is utilized to create cross-linking in polyethylene at variable doses depending on implant manufacturer. McKellop *et al* (43) discovered that crosslink density and crystallinity increases with increased doses of radiation, and wear rates are reduced up to radiation doses of 200 kGy. Saturation of cross-linking occurs at approximately 100 kGy (44). However, radiation cross-linking decreases ductility, which manifests as a reduction in elongation to failure, toughness, and fatigue crack propagation resistance (45), with tensile and fracture toughness continuing to decline at radiation doses beyond 100 kGy (43,46,47). For these reasons, a dose of approximately 100 kGy represents an acceptable balance between crosslink density, wear reduction, and maintenance of important mechanical properties in HXLPE.

In order to maintain the wear-reducing benefits of cross-linking while minimizing the potential for oxidative degradation, two major thermal free radical stabilization processes were developed as part of the first generation of HXLPE bearings. The first, known as remelting, involves heating irradiated polyethylene to some temperature above its melting point ($\sim 137^{\circ}\text{C}$) whereas the second, known as annealing, involves heating irradiated polyethylene to a temperature below its melting point. Both then undergo a cooling and recrystallization process. The desired outcome in both of these processes is to mobilize free radicals within the crystalline region to allow cross-linking and termination of free radicals and thus avoid the potential for oxidation (14,20). When polyethylene is remelted, the rigid crystalline regions are able to mobilize and free radicals present in these regions can reconnect or cross-link, leaving undetectable levels of free radicals (48). Chain mobility and reformation of crystallites during the recrystallization process is limited by the presence of crosslinks, therefore the total crystallinity after remelting is reduced (45). As the strength of UHMWPE is dependent on its relative crystallinity, remelted HXLPE demonstrates decreased ultimate strength, yield strength, and fatigue resistance (14,45). When polyethylene is annealed, not all crystalline lamellae are melted and as such, not all free radicals are stabilized. The relative crystallinity of annealed HXLPE remains nearly unchanged, as do the mechanical properties (49,50). Though differences exist in the physical and mechanical properties of first generation HXLPE liners based on thermal free radical stabilization process, both have demonstrated superior surface wear characteristics, *in vitro* and *in vivo*, compared to conventional UHMWPE THA bearings (9).

2.4 The Impact of Oxidation on First Generation HXLPE Acetabular Liners

2.4.1 Oxidation and Mechanical Properties of HXLPE Acetabular Liners in Experimental Models

A number of experimental studies have been performed to assess the oxidative stability of both types of first generation HXLPE bearings. Oxidation index (OI), the most common way polyethylene oxidation is reported in the literature, is assessed by Fourier transform infrared spectroscopy (FTIR) and is the gold standard for assessment of

oxidation. The OI is calculated from FTIR by normalizing the absorption peak of carbonyl groups, formed from the oxidation of polyethylene chains, against an internal reference absorption peak for the polyethylene. McKellop *et al* (43) demonstrated, in an accelerated aging study, that remelted HXLPE THA bearings demonstrated no evidence of oxidation whereas untreated HXLPE liners demonstrated significant subsurface oxidation. A number of other studies directly compared annealed and remelted first generation HXLPE liners utilizing different aging protocols (38,51,52). These studies found evidence of significant oxidation in annealed liners with no detectable evidence of oxidation in remelted liners. Annealed liners also demonstrated increased wear rates compared to remelted liners (51,52). Although remelted HXLPE liners have shown undetectable levels of free radicals and no evidence of oxidation in these accelerated aging studies, recent studies have demonstrated that remelted HXLPE liners do indeed have the potential to oxidize. Medel *et al* (21) performed a cyclic loading and accelerated aging experimental study on remelted and annealed HXLPE. Annealed HXLPE demonstrated significant evidence of oxidation after aging with evidence of delamination after aging and cyclic loading. Remelted HXLPE samples had minimal or no oxidation when the material was subjected to either cyclic stress or artificial aging steps alone, but significant increases in oxidation and crystallinity were found when the implants were subjected to consecutive cycles of aging and cyclic stress. Oral *et al* (22) exposed remelted HXLPE to synovial fluid lipids and accelerated aging stress. Despite the implants lacking detectable free radicals, the author found that exposure to squalene can lead to significant oxidation, with an OI as low as 0.1 leading to a loss of crosslink density by nearly one half. In another experiment by Oral *et al* (20), remelted HXLPE demonstrated increased oxidation and decreased crosslink density with increasing levels of radiation after accelerated aging, with wear rates increasing with an OI as low as 0.1 and a drastic increase with OI above 1. Similarly, Fung *et al* (23) found a strong positive correlation between maximum OI and average initial transvinylene index (TVI), the byproduct of radiation exposure in polyethylene. Furthermore, it was found that the oxidation index at which mechanical properties were compromised to below ASTM minimum requirements was below one for remelted HXLPE regardless of the amount of radiation used for cross-linking.

2.4.2 Oxidation and Mechanical Properties of Retrieved Annealed HXLPE Acetabular Liners

Retrieval studies have provided great insight into the behavior of first generation HXLPE acetabular liners after time *in vivo* and have confirmed a number of findings from experimental studies. Wannomae *et al* (53) assessed 14 retrieved annealed and 12 retrieved remelted liners with *in vivo* times up to three years. Samples were taken from non-articulating regions near the rim. The remelted liners exhibited no detectable oxidation, whereas the annealed liners demonstrated evidence of oxidation in the subsurface region, with OI ranging from range 0.22 to 5.81. Remelted liners had no significant change in crystallinity compared to controls, while annealed liners showed a significant increase in crystallinity, especially when the OI was greater than 1.0. A strong correlation was found between oxidation and crystallinity but only a weak correlation for oxidation and *in vivo* time. This study suggested that remelting was a superior free radical stabilization technique compared to annealing as it led to a reduced the risk of *in vivo* oxidation and structural property changes.

Currier *et al* (54) evaluated 12 annealed HXLPE liners with *in vivo* time up to 5.3 years for oxidation and evidence of degradation at the rim and articular surface. There was evidence of significant oxidation, with the most marked oxidation at the implant rim, and a strong relationship between rim oxidation and *in vivo* time. Rim cracking was also noted to correlate to *in vivo* time, with the crack rating correlating to oxidation. Rim delamination was found to correlate only with *in vivo* time when taking into account signs of impingement. The authors concluded that annealed HXLPE THA liners oxidize *in vivo* to a significant enough degree to compromise mechanical properties and lead to fatigue damage, especially in the setting if impingement of the femoral neck on the acetabular rim.

A number of retrieval studies led by Kurtz (55–57) have assessed annealed HXLPE liners with *in vivo* times up to 8 years for oxidation and mechanical property changes. These studies demonstrated that these liners preferentially oxidize at the rim and the unloaded regions of the articular surface, indicating that the femoral head may play a protective role from exposure to molecular oxygen in synovial fluid at the loading region of the

articular surface. Furthermore, *in vivo* time was found to correlate to oxidation of the unworn articular surface and the rim, but did not correlate with oxidation values at the worn regions. These studies assessed the mechanical properties of the articular surface and found no appreciable correlation between *in vivo* time and mechanical behavior. It is evident from these studies that oxidation of annealed HXLPE liners occurs preferentially in regions exposed to larger amounts of synovial fluid turnover. Additionally, the mechanical properties of the implants, though only tested along the articular surface, did not appear to be impacted by *in vivo* time. However, rim mechanical properties were not tested, despite being the region of greatest oxidation.

MacDonald *et al* (15), in a large retrieval study assessing oxidation and articular surface mechanical properties of 80 annealed HXLPE acetabular liners with *in vivo* time ranging from 0 to 10.3 years, found moderate oxidation at the rim in annealed liners with over half of these liners demonstrating severe rim oxidation ($OI > 3$). Rim oxidation did correlate with *in vivo* time. Oxidation was also found at the articular surface and was found to correlate with a reduction in ultimate load in this region of the implant. These findings imply that *in vivo* oxidation of annealed HXLPE THA liners leads to a compromise in the mechanical properties, as found in the testing of the articular surface of these implants. However, rim mechanical properties were not tested and it is unclear if a similar change in mechanical properties occurs in this region given the sharp elevations in oxidation with *in vivo* time.

2.4.3 Oxidation and Mechanical Properties of Retrieved Remelted HXLPE Acetabular Liners

Retrieval studies of first generation remelted HXLPE acetabular liners, in corroboration with the above experimental studies, have provided insight into additional mechanisms of *in vivo* oxidation of HXLPE implants. Though a number of experimental and some early retrieval studies pointed to remelted HXLPE liners being resistant to oxidation, recent studies have indicated that these liners show measurable levels of oxidation after *in vivo* service time. Currier *et al* (16) reviewed 50 remelted HXLPE acetabular liners with *in vivo* times for evidence of oxidation, finding detectable levels of oxidation ($OI > 0.1$) in 22% of retrieved inserts after an average of over 2 years *in vivo*, with a positive

correlation between oxidation and *in vivo* time. Another retrieval analysis (17) of 11 remelted HXLPE liners with *in vivo* time of 2 weeks to 7.2 years, also found evidence of subsurface articular surface oxidation after *in vivo* exposure, though *ex vivo* time after surgical removal was not controlled. MacDonald *et al* (15), in the above noted study, also assessed oxidation and articular surface mechanical properties of 160 retrieved remelted HXLPE liners with *in vivo* time ranging from 0 to 11.4 years. Results demonstrated detectable levels of oxidation at the articular surface with a positive correlation to *in vivo* time, however no such relationship was found at the rim or backside of the liner and no significant changes in articular surface mechanical properties were noted. Muratoglu *et al* (18) assessed oxidation, crystallinity and crosslink density of 34 remelted HXLPE liners after removal and shelf aging (*ex vivo*) time. Shelf aged control remelted liners demonstrated no evidence of oxidation at 7 years. Low but detectable oxidation was found at the rim of retrieved implants immediately after surgical removal, and after shelf aging both rim and articular surface oxidation increased and were correlated with *ex vivo* time, but not *in vivo* time. In spite of this finding of low oxidation, cross link density significantly decreased and crystallinity significantly increased with *ex vivo* time for both the articular surface and rim. Rowell *et al* (19) evaluated a number of different retrieved implant types, including remelted HXLPE acetabular liners, for oxidation and cross link density after surgical removal and accelerated aging. Half of the retrieved remelted HXLPE acetabular liners demonstrated evidence of *in vivo* oxidation, which increased in the subsurface region with accelerated aging. Retrievals without measurable *in vivo* oxidation showed oxidation after *ex vivo* accelerated aging (figure 2-3), with subsurface peaks in the articular surface region and at the surface of unloaded regions. Acetabular rim oxidation was noted to increase with accelerated aging as well.

The evidence compiled by these retrieval and experimental studies in remelted HXLPE liners has led to multiple hypotheses for their loss of oxidative stability despite a lack of detectable free radicals after manufacturing, including radiation dose and TVI (20,23), cyclic mechanical stress at the implant surface (15,18,21) and oxidation of synovial lipids that have diffused into the polyethylene *in vivo* (18,22,24).

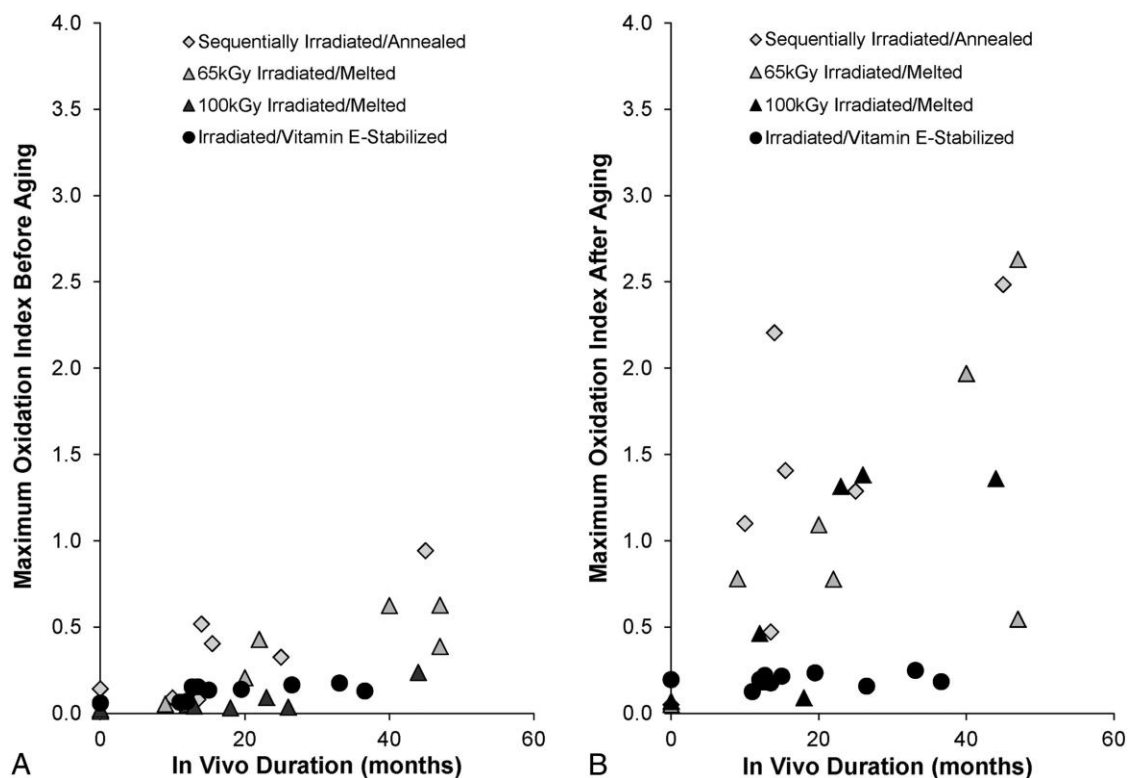

Figure 2-3 - Accelerated aging of retrieved HXLPE liners with various free radical stabilization techniques demonstrates loss of oxidative stability in both remelted and annealed liners. (Permissions from Rowell SL, Reyes CR, Malchau H, Muratoglu OK. *In vivo* Oxidative Stability Changes of Highly Cross-Linked Polyethylene Bearings: An *Ex vivo* Investigation. J Arthroplasty. 2015;30(10):1828-1834. doi:10.1016/j.arth.2015.05.006)

2.4.4 Mechanical Failure of First Generation HXLPE Acetabular Liners

First generation HXLPE liners have proven to be effective in reducing surface wear *in vivo* (9). However, a number of mechanical failures of these liners (25–32) have raised concerns about implant longevity (figure 2-4). Nearly all of these mechanical failures have occurred in first generation remelted HXLPE liners, though one report of annealed HXLPE fracture has been reported (25), and there has been evidence of annealed liner rim delamination (54,57) associated with impingement.

Tower *et al* (26) reported on the mechanical failure of four remelted liners from a single manufacturer after *in vivo* times ranging from 7 to 27 months. In all cases, acetabular components were malpositioned vertically. Analysis of the failed implants exposed severe cracking or failure was at the rim with damage evident at the superior aspect where the polyethylene engages the locking mechanism. Cracking was found to begin at the outer edge of the implant and propagate towards the articular surface. Polyethylene thickness at the site of crack propagation was less than 4mm for each implant. Mechanical properties were nearly identical to control samples, though lower than non-crosslinked reference polyethylene. Moore *et al* (27) and Waewsawangwong and Goodman (28) reported on a mechanical failure in a remelted HXLPE liner with a similar fracture pattern with polyethylene thickness in no greater than 3.3mm at the site of rim fracture. Ast *et al* (29) reported on a single case of a retrieved, fractured remelted HXLPE liner in a vertically oriented acetabular component with polyethylene thickness of 2.2mm at the site of rim fracture. In this study, a review of 74 FDA reported cases of liner fracture in remelted HXLPE implants from the same manufacturer was performed. Average *in vivo* time was 27 months. The majority of cases revealed fracture at the implant rim, with polyethylene thickness ≤ 3.7 mm in 61 of 72 cases and ≤ 4.7 mm in 70 of 72 cases.



Figure 2-4 - Example of a retrieved fractured remelted HXLPE liner at the implant rim. (Permissions from Moore KD, Beck PR, Petersen DW, Cuckler JM, Lemons JE, Eberhardt AW. Early Failure of a Cross-Linked Polyethylene Acetabular Liner: A Case Report. J Bone Joint Surg Am. 2008;90(11):2499-2504. doi:10.2106/JBJS.G.01304)

Duffy *et al* (30) analyzed the physical properties and oxidation in a case of a retrieved, fractured remelted HXLPE liner. The implant fractured along the rim in the region of an elevated 10-degree lip, which was found to be impinging during range of motion of the hip. The implant demonstrated no evidence of oxidation, and the transvinylene index and crystallinity were normal for the radiation dose applied for cross-linking. Furmanski *et al* (31) performed an extensive analysis of 4 retrieved, fractured remelted HXLPE liners from four different manufacturers. Crystallinity of the liners was found to be within expected baseline range, and there was no evidence of oxidation ($OI < 0.1$). In these samples, all fractures initiated on the outer surface of the liners at a region of stress concentration or material discontinuity. Finite element analysis further confirmed that the peak magnitude of the maximum principle tensile stress occurred near the sites of observed crack initiation with values at or above the yield stress of the polyethylene.

Not all reported cases of mechanical failure of HXLPE liners have occurred in remelted liners. Hara *et al* (25) reported a case of liner rim fracture in an annealed HXLPE liner design with a 15 degree elevated lip (figure 2-5). The fracture initiated at the junction of the liner rim and acetabular component dome and propagated towards the articular surface near, but not at, the elevated lip. Polyethylene thickness was no less than 7.4mm throughout the liner. Oxidation was significant along the liner rim (OI = 2.34) and present but low at the articular surface (OI = 0.465).

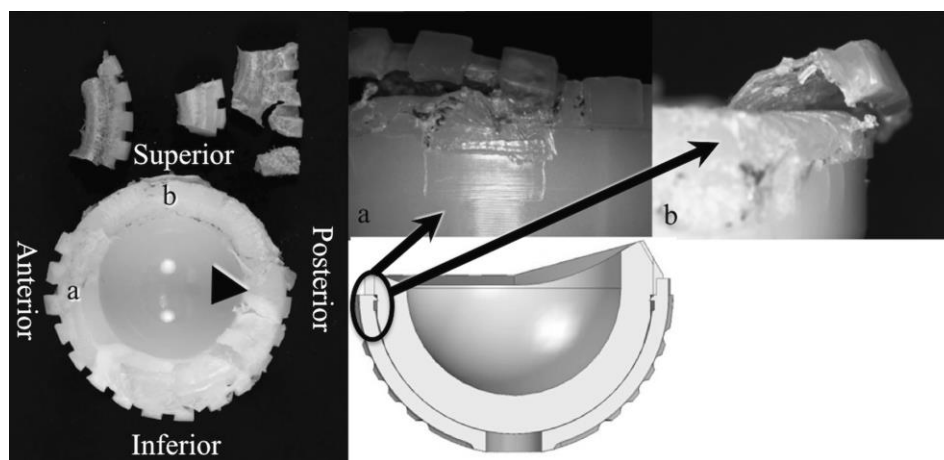

Figure 2-5 - Example of a retrieved fractured annealed HXLPE liner at the implant rim. (Permissions from Hara D, Nakashima Y, Yamamoto T, *et al*. Late failure of annealed highly cross-linked polyethylene acetabular liner. *J Mech Behav Biomed Mater*. 2013;28:206-212. doi:10.1016/j.jmbbm.2013.08.003)

From these studies, it is evident that mechanical failure generally occurs at the implant rim and is a multifactorial problem. A number of potential risks for rim mechanical failure have been proposed including vertical cup orientation with edge loading, femoral neck impingement, polyethylene thickness at the rim below 4.7mm, raised polyethylene rims without metal support, stress concentrators along the outer surface of the rim from notches or locking mechanisms, and the decreased mechanical properties of remelted highly cross-linked polyethylene (25–32,50). Though there is theoretical risk for embrittlement of the implant rim associated with oxidation, research in this area is lacking.

2.5 Second Generation HXLPE: Sequential Annealing and Antioxidant Stabilization

A second generation of HXLPE liners has been developed in an attempt to maintain the superior wear resistance provided by cross-linking while improving oxidative stability mechanical properties (14), and includes sequentially annealed and vitamin-E infused HXLPE.

2.5.1 Sequentially Annealed HXLPE

Sequentially annealed polyethylene was proposed as a way to produce a highly cross-linked polyethylene with the material properties of annealed liners but with little to no residual free radicals (58). In this process, sequential low dose radiation crosslinking (30 kGy) is followed by thermal annealing, and the process is repeated three total times for a total dose of 90 kGy, a dose thought to maximize cross-linking while maintaining mechanical properties. The low dose of radiation is thought to leave cross-links far enough apart to allow sufficient chain mobility for free radicals to mobilize and be extinguished during the annealing phase (59). The implants are then gas plasma sterilized.

Experimental investigation confirmed the potential benefits of sequentially annealing over single annealing used in first generation HXLPE. Dumbleton *et al* (58) and Wang *et al* (60) published on accelerated aging of sequentially annealed compared to single annealed HXLPE and other UHMWPE formulations. Before aging, free radical concentration in the single annealed HXLPE was shown to be over seven times higher and crosslink density was less than half compared to the sequentially annealed HXLPE. Furthermore, oxidation after accelerated aging was found in the subsurface of single annealed HXLPE (OI=1.1), with minimal oxidation (OI=0.05) and maintained crystallinity found in the sequentially annealed HXLPE. Mechanical testing demonstrated the ultimate tensile strength and the amount of material elongation of sequentially annealed HXLPE were higher than that in the single annealed HXLPE, despite the higher cross-linking found in the sequentially annealed material, with no changes in these properties after accelerated aging for the sequentially annealed HXLPE. Wear and

mechanical failure rates in hip simulator analysis was found to be lower in the sequentially annealed compared to single annealed HXLPE liners (58). A number of clinical studies (61–66) found excellent wear rates for sequentially annealed HXLPE.

Retrieval analysis of sequentially annealed THA liners has been limited thus far but has provided important insight into the oxidative stability and mechanical properties of these implants after *in vivo* exposure. In the same study by Rowell (19) noted previously, sequentially annealed HXLPE liners were assessed for oxidation and crosslink density after surgical removal. Oxidation was found at both the implant rim and articular surface, and accelerated aging induced significant increases in oxidation and pre-oxidation products (hydroperoxides) in both regions, along with a significant reduction in crosslink density. Though the levels of oxidation at retrieval were low, this study suggests a potentially significant loss of oxidative stability *in vivo*, likely do to the presence of residual free radicals. Reinitz *et al* (67) assessed 65 sequentially annealed acetabular liners with *in vivo* time ranging from 1 month to 6.4 years. Oxidation trends in these liners were similar to gamma sterilized UHMWPE, with two of the 65 liners demonstrating subsurface white bands along the rim and articular surface with significantly elevated oxidation indices and decreased crosslink density. Kurtz *et al* (68) directly compared oxidation and mechanical properties of 185 retrieved single and sequentially annealed HXLPE liners with *in vivo* time under five years. Oxidation was found along the rim and articular surface in both groups, however the oxidation was significantly lower for the sequentially annealed liners with the most pronounced difference between groups found at the liner rim. Articular surface wear and mechanical properties were similar, and both groups demonstrated a 10% rate of liner rim damage. However, the damage mode of the liner rims in the sequentially annealed group was predominantly burnishing and scratching with no evidence of delamination or subsurface cracking, whereas in the single annealed group there were several samples with rim delamination and subsurface cracking.

Ultimately, sequentially annealed HXLPE liners appear to be an improvement on first generation HXLPE acetabular liners, with mechanical properties that are superior to remelted HXLPE and reduced oxidative potential compared to single annealed HXLPE.

However, retrieval studies do indicate that oxidative degradation does occur, with residual free radicals likely a contributing factor. Long term retrieval studies are needed to understand the clinical impact of these *in vivo* changes.

2.5.2 Antioxidant Stabilized HXLPE

A novel approach to free radical stabilization involves incorporation of antioxidants into HXLPE, namely vitamin E (α -tocopherol), to act as a free radical scavenger while removing the thermal treatment from HXLPE manufacturing, thus allowing for crosslink-associated wear reduction while maintaining the superior mechanical properties of conventional UHMWPE. Two common methods are used for vitamin E incorporation. The first involves blending of vitamin E with UHMWPE powder, followed by consolidation and radiation cross-linking. However, as the vitamin E actively scavenges free radicals during the cross-linking process, the efficacy of radiation cross-linking is reduced, though the concentration of vitamin E throughout the material is relatively homogenous. The second process involves diffusion of vitamin E into cross-linked polyethylene. This method does not impact the cross-linking process, however the diffusion process creates heterogenous concentrations of vitamin E in the polyethylene, requiring a homogenization process at elevated temperatures (69).

In vitro studies have confirmed that vitamin E stabilized HXLPE exhibits superior mechanical properties compared to first generation HXLPE (70,71). Clinical studies have demonstrated similar if not superior wear performance *in vivo* compared to conventional UHMWPE and first generation HXLPE (69,72). The oxidative stability of vitamin E stabilized HXLPE has been shown to be excellent in accelerated aging studies (72). Retrieval analysis of these implants in THA remains fairly limited given the relatively recent introduction of this material. Rowell *et al* (19) demonstrated superior oxidative stability and cross link density in vitamin E stabilized HXLPE compared to other HXLPE formulations after accelerated aging of retrieved implants. In another study of 12 retrieved vitamin E stabilized HXLPE THA liners with *in vivo* times ranging from 0.1 to 36.6 months, minimal oxidation was detected in all liners (maximum OI 0.154). The material properties of retrieved liners were not significantly different from control liners.

Vitamin E stabilized HXLPE liners appear to provide balance between wear, mechanical properties and oxidative stability, however longer term studies and retrieval analysis are needed to better understand the behavior of these implants after extended *in vivo* time in THA.

2.6 Conclusions

The implementation of HXLPE in THA has proven to be highly successful, with a significant reduction on wear rates compared to conventional UHMWPE. The thermal stabilization techniques in the first generation of HXLPE were fairly effective at reducing the free radical content of these implants, however mounting evidence revealing *in vivo* oxidation of both remelted and annealed liners, combined with reports of *in vivo* mechanical failure, raises concerns about the long-term utility of these implants. Second generation stabilization techniques have looked to optimize the balance between cross-linking, mechanical properties and long-term oxidative stability, and early results are encouraging. However longer-term clinical studies and retrieval analysis are needed to assure long term clinical safety and success.

2.7 References

1. Learmonth ID, Young C, Rorabeck C. The operation of the century: total hip replacement. *The Lancet*. 2007;370(9597):1508-1519. doi:10.1016/S0140-6736(07)60457-7
2. Charnley J. Arthroplasty of the hip. A new operation. *Lancet Lond Engl*. 1961;1(7187):1129-1132.
3. Willert HG, Bertram H, Buchhorn GH. Osteolysis in alloarthroplasty of the hip. The role of ultra-high molecular weight polyethylene wear particles. *Clin Orthop*. 1990;(258):95-107.
4. Cooper RA, McAllister CM, Borden LS, *et al*. Polyethylene debris-induced osteolysis and loosening in uncemented total hip arthroplasty. A cause of late failure. *J Arthroplasty*. 1992;7(3):285-290.
5. Ingham E, Fisher J. Biological reactions to wear debris in total joint replacement. *Proc Inst Mech Eng [H]*. 2000;214(1):21-37. doi:10.1243/0954411001535219

6. Ravi B, Croxford R, Reichmann WM, *et al.* The changing demographics of total joint arthroplasty recipients in the United States and Ontario from 2001 to 2007. *Best Pract Res Clin Rheumatol.* 2012;26(5):637-647. doi:10.1016/j.berh.2012.07.014
7. Jacobs CA, Christensen CP, Greenwald AS, *et al.* Clinical performance of highly cross-linked polyethylenes in total hip arthroplasty. *J Bone Joint Surg Am.* 2007;89(12):2779-2786. doi:10.2106/JBJS.G.00043
8. Lachiewicz PF, Soileau ES. Highly Cross-linked Polyethylene Provides Decreased Osteolysis and Reoperation at Minimum 10-Year Follow-Up. *J Arthroplasty.* 2016;31(9):1959-1962. doi:10.1016/j.arth.2016.02.038
9. Kurtz SM, Gawel HA, Patel JD. History and systematic review of wear and osteolysis outcomes for first-generation highly crosslinked polyethylene. *Clin Orthop.* 2011;469(8):2262-2277. doi:10.1007/s11999-011-1872-4
10. Glyn-Jones S, Thomas GER, Garfjeld-Roberts P, *et al.* The John Charnley Award: Highly crosslinked polyethylene in total hip arthroplasty decreases long-term wear: a double-blind randomized trial. *Clin Orthop.* 2015;473(2):432-438. doi:10.1007/s11999-014-3735-2
11. Paxton EW, Inacio MCS, Namba RS, *et al.* Metal-on-conventional polyethylene total hip arthroplasty bearing surfaces have a higher risk of revision than metal-on-highly crosslinked polyethylene: results from a US registry. *Clin Orthop.* 2015;473(3):1011-1021. doi:10.1007/s11999-014-4105-9
12. Paxton E, Cafri G, Havelin L, *et al.* Risk of Revision Following Total Hip Arthroplasty: Metal-on-Conventional Polyethylene Compared with Metal-on-Highly Cross-Linked Polyethylene Bearing Surfaces: International Results from Six Registries. *J Bone Joint Surg Am.* 2014;96(Suppl 1):19-24. doi:10.2106/JBJS.N.00460
13. Hanna SA, Somerville L, McCalden RW, *et al.* Highly cross-linked polyethylene decreases the rate of revision of total hip arthroplasty compared with conventional polyethylene at 13 years' follow-up. *Bone Jt J.* 2016;98-B(1):28-32. doi:10.1302/0301-620X.98B1.36527
14. Bracco P, Bellare A, Bistolfi A, *et al.* Ultra-High Molecular Weight Polyethylene: Influence of the Chemical, Physical and Mechanical Properties on the Wear Behavior. A Review. *Mater Basel Switz.* 2017;10(7). doi:10.3390/ma10070791
15. MacDonald D, Sakona A, Ianuzzi A, *et al.* Do First-generation Highly Crosslinked Polyethylenes Oxidize *In vivo*? *Clin Orthop Relat Res.* 2011;469(8):2278-2285. doi:10.1007/s11999-010-1728-3
16. Currier BH, Van Citters DW, Currier JH, *et al.* *In vivo* Oxidation in Remelted Highly Cross-Linked Retrievals: *J Bone Joint Surg Am.* 2010;92(14):2409-2418. doi:10.2106/JBJS.I.01006

17. Miura Y, Hasegawa M, Sudo A, *et al.* In-vivo degradation of middle-term highly cross-linked and remelted polyethylene cups: Modification induced by creep, wear and oxidation. *J Mech Behav Biomed Mater.* 2015;51:13-24. doi:10.1016/j.jmbbm.2015.06.028
18. Muratoglu OK, Wannomae KK, Rowell SL, *et al.* Ex vivo stability loss of irradiated and melted ultra-high molecular weight polyethylene. *J Bone Joint Surg Am.* 2010;92(17):2809-2816. doi:10.2106/JBJS.I.01017
19. Rowell SL, Reyes CR, Malchau H, *et al.* In vivo Oxidative Stability Changes of Highly Cross-Linked Polyethylene Bearings: An Ex vivo Investigation. *J Arthroplasty.* 2015;30(10):1828-1834. doi:10.1016/j.arth.2015.05.006
20. Oral E, Neils AL, Doshi BN, Fu J, *et al.* Effects of simulated oxidation on the *in vitro* wear and mechanical properties of irradiated and melted highly crosslinked UHMWPE. *J Biomed Mater Res B Appl Biomater.* 2016;104(2):316-322. doi:10.1002/jbm.b.33368
21. Medel F, Kurtz S, MacDonald D, *et al.* Does cyclic stress play a role in highly crosslinked polyethylene oxidation? *Clin Orthop.* 2015;473(3):1022-1029. doi:10.1007/s11999-015-4153-9
22. Oral E, Ghali BW, Neils A, *et al.* A new mechanism of oxidation in ultrahigh molecular weight polyethylene caused by squalene absorption. *J Biomed Mater Res B Appl Biomater.* 2012;100(3):742-751. doi:10.1002/jbm.b.32507
23. Fung M, Bowsher JG, Van Citters DW. Variation of mechanical properties and oxidation with radiation dose and source in highly crosslinked remelted UHMWPE. *J Mech Behav Biomed Mater.* 2018;82:112-119. doi:10.1016/j.jmbbm.2018.03.005
24. Costa L, Bracco P, del Prever EB, *et al.* Analysis of products diffused into UHMWPE prosthetic components *in vivo.* *Biomaterials.* 2001;22(4):307-315.
25. Hara D, Nakashima Y, Yamamoto T, *et al.* Late failure of annealed highly cross-linked polyethylene acetabular liner. *J Mech Behav Biomed Mater.* 2013;28:206-212. doi:10.1016/j.jmbbm.2013.08.003
26. Tower SS. Rim Cracking of the Cross-Linked Longevity Polyethylene Acetabular Liner After Total Hip Arthroplasty. *J Bone Joint Surg Am.* 2007;89(10):2212. doi:10.2106/JBJS.F.00758
27. Moore KD, Beck PR, Petersen DW, *et al.* Early Failure of a Cross-Linked Polyethylene Acetabular Liner: A Case Report. *J Bone Joint Surg Am.* 2008;90(11):2499-2504. doi:10.2106/JBJS.G.01304
28. Waewsawangwong W, Goodman SB. Unexpected Failure of Highly Cross-Linked Polyethylene Acetabular Liner. *J Arthroplasty.* 2012;27(2):323.e1-323.e4. doi:10.1016/j.arth.2011.04.010

29. Ast MP, John TK, Labbisiere A, *et al.* Fractures of a single design of highly cross-linked polyethylene acetabular liners: an analysis of voluntary reports to the United States Food and Drug Administration. *J Arthroplasty*. 2014;29(6):1231-1235. doi:10.1016/j.arth.2013.12.022
30. Duffy GP, Wannomae KK, Rowell SL, *et al.* Fracture of a Cross-Linked Polyethylene Liner Due to Impingement. *J Arthroplasty*. 2009;24(1):158.e15-158.e19. doi:10.1016/j.arth.2007.12.020
31. Furmanski J, Anderson M, Bal S, *et al.* Clinical fracture of cross-linked UHMWPE acetabular liners. *Biomaterials*. 2009;30(29):5572-5582. doi:10.1016/j.biomaterials.2009.07.013
32. Blumenfeld TJ, McKellop HA, Schmalzried TP, *et al.* Fracture of a Cross-Linked Polyethylene Liner. *J Arthroplasty*. 2011;26(4):666.e5-666.e8. doi:10.1016/j.arth.2010.07.009
33. ASTM D4020-01, Standard Specification for Ultra-High-Molecular-Weight Polyethylene Molding and Extrusion Materials. doi:10.1520/D4020-01
34. Kurtz SM. 1 - A Primer on UHMWPE. In: *UHMWPE Biomaterials Handbook (Third Edition)*. Oxford: William Andrew Publishing; 2016:1-6. doi:10.1016/B978-0-323-35401-1.00001-6
35. Kurtz SM. 2 - From Ethylene Gas to UHMWPE Component: The Process of Producing Orthopedic Implants. In: *UHMWPE Biomaterials Handbook (Third Edition)*. Oxford: William Andrew Publishing; 2016:7-20. doi:10.1016/B978-0-323-35401-1.00002-8
36. Kurtz SM, Zagorski M. 3 - Packaging and Sterilization of UHMWPE. In: *UHMWPE Biomaterials Handbook (Third Edition)*. Oxford: William Andrew Publishing; 2016:21-32. doi:10.1016/B978-0-323-35401-1.00003-X
37. Costa L, Bracco P. 26 - Mechanisms of Cross-Linking, Oxidative Degradation, and Stabilization of UHMWPE. In: Kurtz SM, ed. *UHMWPE Biomaterials Handbook (Third Edition)*. Oxford: William Andrew Publishing; 2016:467-487. doi:10.1016/B978-0-323-35401-1.00026-0
38. Collier JP, Currier BH, Kennedy FE, *et al.* Comparison of cross-linked polyethylene materials for orthopaedic applications. *Clin Orthop*. 2003;(414):289-304. doi:10.1097/01.blo.0000073343.50837.03
39. Hopper RH, Young AM, Orishimo KF, *et al.* Effect of terminal sterilization with gas plasma or gamma radiation on wear of polyethylene liners. *J Bone Joint Surg Am*. 2003;85-A(3):464-468.

40. Wang A, Essner A, Polineni V, *et al.* Lubrication and wear of ultra-high molecular weight polyethylene in total hip replacements. *Tribol Int.* 1998;31:17-33. doi:10.1016/S0301-679X(98)00005-X
41. McKellop HA, Shen FW, Campbell P, *et al.* Effect of molecular weight, calcium stearate, and sterilization methods on the wear of ultra high molecular weight polyethylene acetabular cups in a hip joint simulator. *J Orthop Res Off Publ Orthop Res Soc.* 1999;17(3):329-339. doi:10.1002/jor.1100170306
42. Kurtz SM, Oral E. 27 - *In vivo* Oxidation of UHMWPE. In: *UHMWPE Biomaterials Handbook (Third Edition)*. Oxford: William Andrew Publishing; 2016:488-505. doi:10.1016/B978-0-323-35401-1.00027-2
43. McKellop H, Shen F, Lu B, *et al.* Development of an extremely wear-resistant ultra high molecular weight polyethylene for total hip replacements. *J Orthop Res.* 1999;17(2):157-167. doi:10.1002/jor.1100170203
44. Kurtz SM, Patel JD. 6 - The Clinical Performance of Highly Cross-linked UHMWPE in Hip Replacements. In: *UHMWPE Biomaterials Handbook (Third Edition)*. Oxford: William Andrew Publishing; 2016:57-71. doi:10.1016/B978-0-323-35401-1.00006-5
45. Muratoglu OK, Bragdon CR. 15 - Highly Cross-Linked and Melted UHMWPE. In: Kurtz SM, ed. *UHMWPE Biomaterials Handbook (Third Edition)*. Oxford: William Andrew Publishing; 2016:264-273. doi:10.1016/B978-0-323-35401-1.00015-6
46. Gomoll A, Wanich T, Bellare A. J-integral fracture toughness and tearing modulus measurement of radiation cross-linked UHMWPE. *J Orthop Res Off Publ Orthop Res Soc.* 2002;20(6):1152-1156. doi:10.1016/S0736-0266(02)00073-6
47. Baker DA, Bellare A, Pruitt L. The effects of degree of crosslinking on the fatigue crack initiation and propagation resistance of orthopedic-grade polyethylene. *J Biomed Mater Res A.* 2003;66(1):146-154. doi:10.1002/jbm.a.10606
48. Muratoglu OK, Bragdon CR, O'Connor DO, *et al.* A novel method of cross-linking ultra-high-molecular-weight polyethylene to improve wear, reduce oxidation, and retain mechanical properties. Recipient of the 1999 HAP Paul Award. *J Arthroplasty.* 2001;16(2):149-160. doi:10.1054/arth.2001.20540
49. Atwood SA, Van Citters DW, Patten EW, *et al.* Tradeoffs amongst fatigue, wear, and oxidation resistance of cross-linked ultra-high molecular weight polyethylene. *J Mech Behav Biomed Mater.* 2011;4(7):1033-1045. doi:10.1016/j.jmbbm.2011.03.012
50. Pruitt LA, Ansari F, Kury M, *et al.* Clinical trade-offs in cross-linked ultrahigh-molecular-weight polyethylene used in total joint arthroplasty. *J Biomed Mater Res B Appl Biomater.* 2013;101B. doi:10.1002/jbm.b.32887

51. Muratoglu OK, Merrill EW, Bragdon CR, *et al.* Effect of radiation, heat, and aging on *in vitro* wear resistance of polyethylene. *Clin Orthop.* 2003;(417):253-262. doi:10.1097/01.blo.0000093004.90435.d1
52. Wannomae KK, Christensen SD, Freiberg AA, *et al.* The effect of real-time aging on the oxidation and wear of highly cross-linked UHMWPE acetabular liners. *Biomaterials.* 2006;27(9):1980-1987. doi:10.1016/j.biomaterials.2005.10.002
53. Wannomae KK, Bhattacharyya S, Freiberg A, *et al.* *In vivo* oxidation of retrieved cross-linked ultra-high-molecular-weight polyethylene acetabular components with residual free radicals. *J Arthroplasty.* 2006;21(7):1005-1011. doi:10.1016/j.arth.2005.07.019
54. Currier BH. Evaluation of Oxidation and Fatigue Damage of Retrieved Crossfire Polyethylene Acetabular Cups. *J Bone Joint Surg Am.* 2007;89(9):2023. doi:10.2106/JBJS.F.00336
55. Kurtz SM, Hozack W, Turner J, *et al.* Mechanical Properties of Retrieved Highly Cross-Linked Crossfire Liners After Short-Term Implantation. *J Arthroplasty.* 2005;20(7):840-849. doi:10.1016/j.arth.2005.07.015
56. Kurtz SM, Hozack WJ, Purtill JJ, *et al.* 2006 Otto Aufranc Award Paper: Significance of *In vivo* Degradation for Polyethylene in Total Hip Arthroplasty: *Clin Orthop.* 2006;453:47-57. doi:10.1097/01.blo.0000246547.18187.0b
57. Kurtz SM, Austin MS, Azzam K, *et al.* Mechanical Properties, Oxidation, and Clinical Performance of Retrieved Highly Cross-Linked Crossfire Liners After Intermediate-Term Implantation. *J Arthroplasty.* 2010;25(4):614-623.e2. doi:10.1016/j.arth.2009.04.022
58. Dumbleton JH, D'Antonio JA, Manley MT, *et al.* The basis for a second-generation highly cross-linked UHMWPE. *Clin Orthop.* 2006;453:265-271. doi:10.1097/01.blo.0000238856.61862.7d
59. Manley MT. 16 - Highly Cross-Linked and Annealed UHMWPE. In: Kurtz SM, ed. *UHMWPE Biomaterials Handbook (Third Edition)*. Oxford: William Andrew Publishing; 2016:274-292. doi:10.1016/B978-0-323-35401-1.00016-8
60. Wang A, Zeng H, Yau S-S, *et al.* Wear, oxidation and mechanical properties of a sequentially irradiated and annealed UHMWPE in total joint replacement. *J Phys Appl Phys.* 2006;39(15):3213. doi:10.1088/0022-3727/39/15/S12
61. Callary SA, Field JR, Campbell DG. Low wear of a second-generation highly crosslinked polyethylene liner: a 5-year radiostereometric analysis study. *Clin Orthop.* 2013;471(11):3596-3600. doi:10.1007/s11999-013-3188-z

62. Campbell DG, Field JR, Callary SA. Second-generation highly cross-linked X3™ polyethylene wear: a preliminary radiostereometric analysis study. *Clin Orthop*. 2010;468(10):2704-2709. doi:10.1007/s11999-010-1259-y
63. Gascoyne TC, Petrak MJ, Turgeon TR, *et al*. Wear of a sequentially annealed polyethylene acetabular liner. *Acta Orthop*. 2014;85(5):470-473. doi:10.3109/17453674.2014.949044
64. D'Antonio JA, Capello WN, Ramakrishnan R. Second-generation annealed highly cross-linked polyethylene exhibits low wear. *Clin Orthop*. 2012;470(6):1696-1704. doi:10.1007/s11999-011-2177-3
65. D'Antonio JA, Capello WN, Mesko JW, *et al*. Second-Generation Annealed Highly Crosslinked Polyethylene has Low Wear at Mean Seven Year Follow-up. *Surg Technol Int*. 2014;25:219-226.
66. Sayeed SA, Mont MA, Costa CR, *et al*. Early outcomes of sequentially cross-linked thin polyethylene liners with large diameter femoral heads in total hip arthroplasty. *Bull NYU Hosp Jt Dis*. 2011;69(SUPPL. 1). <https://cwru.pure.elsevier.com/en/publications/early-outcomes-of-sequentially-cross-linked-thin-polyethylene-lin>. Accessed June 15, 2018.
67. Reinitz SD, Currier BH, Van Citters DW, *et al*. Oxidation and other property changes of retrieved sequentially annealed UHMWPE acetabular and tibial bearings. *J Biomed Mater Res B Appl Biomater*. 2015;103(3):578-586. doi:10.1002/jbm.b.33240
68. Kurtz SM, MacDonald DW, Mont MA, *et al*. Retrieval analysis of sequentially annealed highly crosslinked polyethylene used in total hip arthroplasty. *Clin Orthop*. 2015;473(3):962-971. doi:10.1007/s11999-014-4113-9
69. Oral E, Muratoglu OK. 18 - Highly Cross-Linked UHMWPE Doped with Vitamin E. In: Kurtz SM, ed. *UHMWPE Biomaterials Handbook (Third Edition)*. Oxford: William Andrew Publishing; 2016:307-325. doi:10.1016/B978-0-323-35401-1.00018-1
70. Oral E, Wannomae KK, Hawkins N, *et al*. Alpha-tocopherol-doped irradiated UHMWPE for high fatigue resistance and low wear. *Biomaterials*. 2004;25(24):5515-5522. doi:10.1016/j.biomaterials.2003.12.048
71. Oral E, Christensen SD, Malhi AS, *et al*. Wear resistance and mechanical properties of highly cross-linked, ultrahigh-molecular weight polyethylene doped with vitamin E. *J Arthroplasty*. 2006;21(4):580-591. doi:10.1016/j.arth.2005.07.009
72. Oral E, Muratoglu OK. Vitamin E diffused, highly crosslinked UHMWPE: a review. *Int Orthop*. 2011;35(2):215-223. doi:10.1007/s00264-010-1161-y

Chapter 3

3 Thesis Outline and Summary

In chapters one and two of this thesis, the success of total hip arthroplasty (THA) in reducing pain and improving function in patients with arthritic conditions of the hip has been outlined. Improving the longevity of THA implants remains essential, as revision surgery carries significant patient morbidity and financial costs, and demand for THA continues to increase in the setting of both an aging population and the increased use of THA in younger patients. The introduction of highly cross-linked polyethylene (HXLPE) into THA has improved polyethylene wear and reduced wear-related revision surgery. However, thermal free radical stabilization techniques, used in the processing of HXLPE to improve oxidative stability, alter the implant mechanical properties. Furthermore, *in vivo* oxidation, known to degrade polyethylene mechanical properties, has been detected in all forms of thermally stabilized HXLPE liners. Given these concerns and multiple reports of HXLPE liner mechanical failures at the implant rim raise concerns about the longevity of these implants.

In this thesis, impact of extended *in vivo* time on the mechanical and physical properties of HXLPE acetabular liners will be assessed. To understand the mechanical properties, a validated mechanical testing method will be used to assess retrieved HXLPE acetabular liner rims. A number of different testing methods will then be used to determine the extent of implant oxidation and changes in polyethylene physical properties after *in vivo* exposure. Based on the current understanding of HXLPE mechanical properties and *in vivo* oxidation, it is hypothesized that liners stabilized with thermal annealing will demonstrate a significant reduction in mechanical properties, increased evidence of oxidation, and an increase in relative crystallinity compared to those that are remelted.

In chapter four, the details of the testing methodology used to determine mechanical properties, oxidation and crystallinity will be discussed along with evidence for use of these methods on medical grade polyethylene.

In chapter five, the results of the mechanical testing of retrieved HXLPE acetabular liner rims after extended time *in vivo* will be discussed. In this study, retrieved HXLPE liners all had an *in vivo* time of 4.5 years or greater. Implants were categorized by their thermal free radical stabilization technique and included remelted, single annealed, or sequentially annealed groups. The purpose of this study is to understand the impact of *in vivo* time on HXLPE liner rim mechanical properties based on differences in thermal treatments.

In chapter six, the results of oxidation and crystallinity assessment of HXLPE acetabular liner rims will be discussed. All retrieved HXLPE acetabular liners in this study have an *ex vivo* time of under one year to minimize the potential impact of shelf oxidation on testing results. Oxidation and crystallinity are assessed at both the acetabular liner rim and at the articular surface of the implant for comparison. The purpose of this study is to assess for evidence of oxidation and subsequent changes in physical properties of HXLPE liner rims after prolonged *in vivo* time and correlate these findings with the measured mechanical properties above.

Finally, chapter seven will discuss the combined findings of the studies in this thesis, the clinical relevance of these findings, and potential future research directions based on these results.

Chapter 4

4 Methodology for the Assessment of Physical and Mechanical Properties of Highly Cross-Linked Polyethylene

Ultra-high molecular weight polyethylene (UHMWPE) used as a bearing surface in total hip arthroplasty (THA) has led to a long track record of success (1). However, implant longevity may be compromised due to wear of conventional UHMWPE, leading to bone resorption around the implant and subsequent implant loosening (2). The introduction of highly crosslinked polyethylene (HXLPE) to improve wear characteristics of acetabular liners (3) has proven to be highly clinically successful, with reduction in wear-related revision surgery compared to conventional UHMWPE acetabular liners (4-10).

Improvement in wear resistance of HXLPE liners comes at the expense of the mechanical properties of the liner (11). Radiation cross-linking of UHMWPE relies on the formation of free radicals. These free radicals recombine in the amorphous region of UHMWPE in order to create cross-linking. Radiation cross-linking decreases ductility, manifesting as reduction in toughness and fatigue crack propagation resistance (12,13). Free radicals in the crystalline regions are unable to recombine and become trapped, later able to react with oxygen species and lead to polymer chain scission, recrystallization and ultimately increased brittleness (13,14). One method of removing these free radicals is thermal stabilization through remelting or annealing irradiated polyethylene. Remelting effectively removes free radicals, however this results in decreased crystallinity and subsequently decreased mechanical properties (13,15). Annealing leaves residual free radicals while maintaining crystallinity and mechanical properties. Furthermore, certain manufacturers utilize irradiation for implant sterilization, which can reintroduce or increase free radicals in the finished implant (16) depending on the sterilization environment and thermal stabilization technique.

In vivo oxidation of HXLPE acetabular liners has been demonstrated in liners stabilized by annealing as well as remelting (17-26). The acetabular liner rim is particularly susceptible to *in vivo* oxidation (23). Furthermore, radiation dose (14,27), cyclic

mechanical loading (28) and biologic prooxidants (29,30) may play a role in oxidation of HXLPE. With extensive *in vivo* oxidation, the mechanical properties of UHMWPE have been shown to be severely compromised (31).

There have been a number of reports of mechanical failure of HXLPE acetabular liners at the rim of the implant. A number of potential risks for these failures have been identified, including the inherently reduced mechanical properties of HXLPE, mechanical loading of the rim through impingement, thinner liners and unprotected liner rim designs (32-39). Given the *in vivo* oxidative potential for both annealed and remelted HXLPE, evidence of preferential oxidation of the acetabular rim, and the reduced mechanical properties of HXLPE, it is suspected that oxidation and subsequent changes to the polyethylene microstructure may contribute to these rim failures. However, to this point there have been no studies directly assessing HXLPE liner rims for oxidative, structural and mechanical property changes after prolonged *in vivo* time. It is hypothesized that there will be evidence of increased oxidation, increased crystallinity and decreased mechanical properties at the rim of acetabular HXLPE liners after extended *in vivo* exposure, and that annealed acetabular liners will demonstrate significantly greater oxidation and crystallinity along with worsened mechanical properties compared to remelted liners.

4.1 Indentation Testing

Material hardness refers to the ability of a material to resist deformation. It is directly related to the elastic modulus of a material (40). Depth-sensing indentation (DSI) is a well-established hardness test utilized in the study of mechanical properties of orthopaedic UHMWPE implants. DSI testing is generally performed by driving a hard indenter tip of known geometry into the surface of a sample to be tested. This load can be maintained on the samples surface for a fixed period of time (“dwell time”) if the material demonstrates viscoelastic properties, as UHMWPE does, in order to allow creep-like deformation to occur (41). A measurable deformation is created on the sample surface. Depending on the indenter and test being utilized, either depth or area of the indentation is measured. The Rockwell macrohardness indenter test measures indentation depth, whereas the Brinell (Meyer) macrohardness indenters, Berkovich, Knoop and

Vickers microhardness indenters and Berkovich nanohardness indenter utilize optical measurement of the residual indentation area (42). While both microindentation and nanoindentation DSI has been performed with orthopaedic UHMWPE retrieval studies (40,43-45), microindentation was selected for use in this study for the following reasons. Per the International Organization for Standardization (ISO) 14577, microindentation is defined as a force applied of less than 2N and indentation depth greater than 0.2 μm and nanoindentation is defined by an indentation depth less than or equal to 0.2 μm (46). Given the difference in depth of indentation, microindentation testing provides a more volume-average response of the material in testing whereas nanoindentation provides a focal assessment of hardness along the material surface. In particular, microindentation averages over the scale of crystalline and amorphous regions while penetrating below the surface polymer. Nanoindentation testing of UHMWPE can demonstrate increased variability due to surface roughness and polymer orientation due to wear or sample preparation, as well as heterogeneity in crystalline and amorphous region distribution in the sample (43,47). Microindentation testing has been established as a reliable method for testing UHMWPE and compares favorably to nanoindentation for the purposes of this study (41). Of the available microindentation testing methods, Vickers microhardness test will be utilized for mechanical testing of HXLPE in this project due to its relative insensitivity to surface conditions, ease and reproducibility of measurement due to the constant indentation geometry. For this testing apparatus, a diamond indenter, in the form of a square-based pyramid with an angle of 136 degrees between the opposite faces (figure 4-1) is pressed onto the sample surface using a predefined force (F) between 25 and 1000 gram-force (gf) over a defined time period (dwell time) of 10 to 15 seconds long per ASTM E384 standards (48). The load is removed and the deformation created in the sample surface is measured using an optical microscope. The Vickers hardness number (HV) is calculated as:

$$HV = \frac{2F}{d^2} \left(\sin \frac{136^\circ}{2} \right) = 1.854 \frac{F}{d^2}$$

Where d is the mean diagonal length of the indentation in mm ($d=(d_1+d_2)/2$).

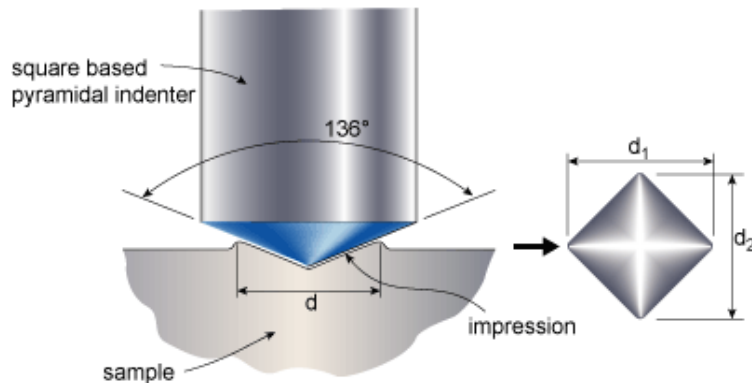

Figure 4-1 – Vickers Microindentation with a square-based diamond tip indenter. The Indenter is loaded into the sample surface with a predefined loading force and dwell time, leaving a residual surface indentation. The resultant diagonal lengths (d_1 and d_2) can be measured under an optical microscope. (Courtesy TWI Ltd. Hardness Testing Part 1 - Job Knowledge 74, <https://www.twi-global.com/technical-knowledge/job-knowledge/hardness-testing-part-1-074/> (accessed 24 June, 2018))

Prior studies have assessed the impact of oxidation on the mechanical properties of orthopaedic UHMWPE implants as assessed with DSI. It has been well established that residual free radicals produced in irradiated UHMWPE can react with oxygen species to induce a sustained formation of oxidation products on polyethylene chains with subsequent chain scission, decrease in molecular mass and an increase in crystallinity (15). Though higher levels of crystallinity of unoxidized UHMWPE can confer improved yield strength, increases in crystallinity due to oxidation decreases the ductility and ultimate strength (31). DSI testing of retrieved and shelf-aged UHMWPE implants with known oxidative damage demonstrated a strong positive linear relationship between oxidation and indentation hardness (40,43).

The impact of cross-linking and oxidation of first generation HXLPE on DSI testing is less well understood. Prior studies have demonstrated that HXLPE has decreased indentation response compared to conventional UHMWPE as measured by DSI (45,49,50). However, implant retrieval studies of both annealed and remelted HXLPE have demonstrated detectable levels of oxidation, which has been shown to increase indentation hardness (40,43). Furthermore, retrieved HXLPE liners with detectable but

low levels of *in vivo* oxidation demonstrate significant increased oxidation with accelerated aging, demonstrating the loss of oxidative stability in both annealed and remelted HXLPE after even very short *in vivo* durations (21). In retrieved THA implants, more marked oxidation has been observed at the implant rim, whereas the articular surface remains relatively protected (23,25). Limited retrieval studies have been performed (17,24-26,51) directly assessing the mechanical properties of these oxidized HXLPE liner, especially at the rim where oxidation can be significant. There have been no published studies, to our knowledge, assessing the impact of extended *in vivo* times on mechanical properties of the acetabular rim of HXLPE liners.

4.2 Assessment of Oxidation

Total radiation, shelf time, *in vivo* service time, *ex vivo* oxygen exposure, mechanical stress and biological contaminants have all been associated with oxidation of UHMWPE. Fourier transform infrared spectroscopy (FTIR) has been proven to be a very effective tool in measuring oxidation of biomedical polyethylene, and as such has become the preferred technique to quantitatively assess oxidation of orthopaedic UHMWPE implants (52).

FTIR passes infrared (IR) radiation through a sample (figure 4-2). The radiation from the IR source is either absorbed by or passes through the sample. The radiation that passes through the sample is transmitted onto a detector, providing information about the wavelengths being absorbed by the sample as well as the quantity of the absorption. Certain chemical structures absorb IR radiation at certain spectra. Therefore, the types of chemical structures present in a sample can be determined based on the absorption spectra from the tested sample.

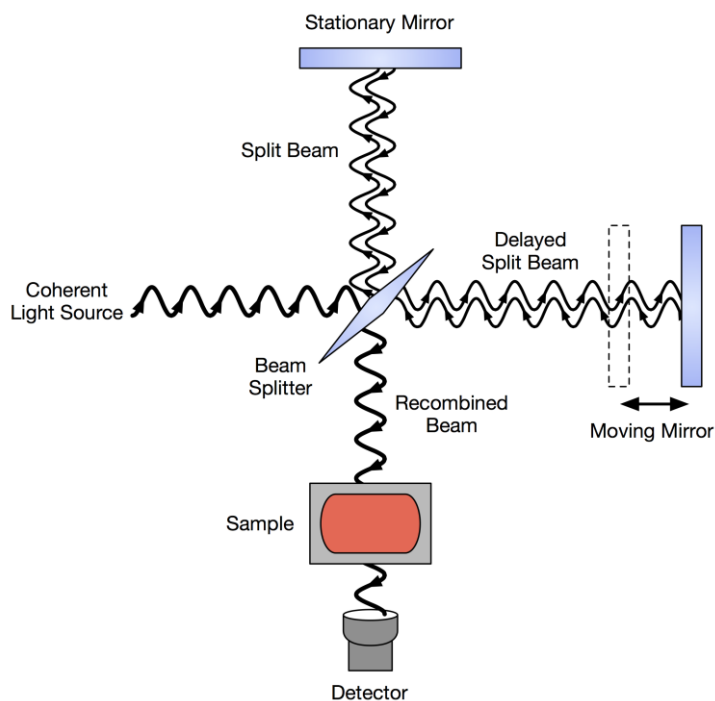

Figure 4-2 – Schematic diagram of an interferometer configured for Fourier transform infrared spectroscopy (Courtesy Wikimedia Commons Public Domain, <https://commons.wikimedia.org/w/index.php?curid=25333405>, accessed 02 July, 2018)

UHMWPE has a relatively simple chemical structure (figure 4-3). When IR radiation is passed through the UHMWPE chains, the methylene groups demonstrate different absorption peaks on the IR spectra based on the movement of bonds within these groups. The 1370cm^{-1} peak represents a wagging vibration of CH_2 groups in the amorphous region, whereas the 2022cm^{-1} peak represents twisting vibration of the CH_2 groups in both the crystalline and amorphous region (52). Prior studies have validated these vibrational peaks as the ideal internal references for measurements of oxidation in orthopaedic UHMWPE implants under various conditions (52-54). When UHMWPE chains are degraded, characteristic absorption peaks are produced depending on the cause of degradation. A terminal vinyl group, which produces an absorption peak at 910cm^{-1} , is formed when polymer chains are broken. Transvinylene groups are formed in polyethylene as cross-links after exposure to ionizing radiation and produce an absorption peak at 965cm^{-1} . When polyethylene is oxidized, carbonyl groups are formed. These

carbonyl groups such as ketones, esters and ethers have an absorption peak between approximately $1710\text{-}1740\text{cm}^{-1}$, typically centered around 1720cm^{-1} (55).

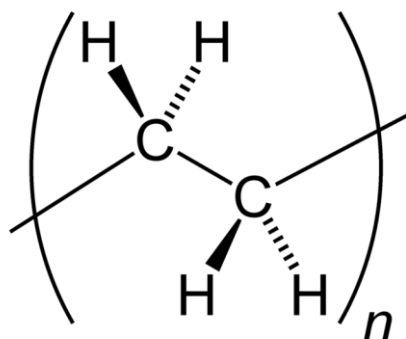

Figure 4-3 – Chemical structure of polyethylene. (Courtesy Wikimedia Commons Public Domain, <https://commons.wikimedia.org/w/index.php?curid=1018160> (accessed 02 July 2018))

When the oxidation peak is normalized against an internal reference, most commonly the 1370cm^{-1} peak (52), an oxidation index (OI) is produced. This value provides a quantitative measure of the extent of polyethylene oxidation. Retrieved liners invariably contain biologic contaminants, such as lipids and proteins, that have absorption peaks near the carbonyl group and can subsequently artificially increase the OI by up to 58% in the articulating region from a depth of 0 to 200 μm . These contaminants can be removed with hexane or heptane boiling to improve the accuracy of conventional FTIR analysis (56). Alternatively, Currier *et al* (23,57) demonstrated that these contaminants seem to preferentially impact absorption around the 1738cm^{-1} band, and as such developed a modified oxidation index that did not depend on lipid extraction. This Dartmouth Oxidation Index, or DOI, is based on the ketone peak at 1718cm^{-1} where oxidation is most prominent. The DOI can be converted to the OI as recognized by the ASTM using the equation $\text{OI} = \text{DOI} \times 1.91$ (23). Similarly, when the transvinylene peak absorption is normalized against an internal reference, a transvinylene index (TVI) is produced. This value quantifies the extent and homogeneity of radiation exposure of the polyethylene and can be useful to understand both the oxidation values and mechanical properties of the implant.

As previously noted, HXLPE acetabular liners thermally treated by remelting and annealing have been shown to undergo detectable levels of oxidation after *in vivo* exposure (17-26), and oxidation tends to occur at higher levels in more exposed regions of the implant such as the rim. It is important to note, as outlined in chapter two, that these studies on retrieved HXLPE acetabular liners have shown mixed results regarding the correlation between rim oxidation and *in vivo* time, indicating that *in vivo* oxidation is multifactorial in nature. Furthermore, what has previously been considered a critical oxidation for conventional UHMWPE implants to maintain mechanical integrity (57) may differ from HXLPE due to differences in mechanical properties and the impact of crosslinking (27,29).

4.3 Assessment of Crystallinity

UHMWPE is a semi-crystalline material containing three phases: crystalline, amorphous, and interphase or tertiary phase. The crystalline phase is characterized by well organized, densely packed lamellae whereas the amorphous phase is fairly disorganized. The crystalline lamellae of UHMWPE are intertwined within the amorphous regions, and the lamellae can connect via short tie molecules.

Radiation cross-linking in HXLPE leads to the formation of free radicals throughout polyethylene chains. Free radicals present in the more mobile amorphous regions can recombine to form crosslinks within the polyethylene chains, whereas those formed in the crystalline region remain trapped (14) do to the rigid lamellar structure. Thermal treatment to stabilize free radicals, either with remelting or annealing, is performed to mobilize these free radicals and allow for chain reformation or cross-linking. When polyethylene is remelted, the rigid crystalline regions are melted and able to mobilize, allowing free radicals to crosslink, however the ability of polyethylene chains to mobilize and reform into crystalline lamellae is compromised and the overall crystallinity remains permanently reduced (13). When polyethylene is annealed, not all crystalline lamellae are melted and as such, not all free radicals are exposed and stabilized. The relative crystallinity of annealed HXLPE remains nearly unchanged. As the strength of UHMWPE is dependent on its relative crystallinity (13), remelted HXLPE demonstrates decreased ultimate strength, yield strength, and fatigue resistance (13,15) whereas

annealed HXLPE mechanical properties tend to be preserved. Residual free radicals in HXLPE can undergo oxidation when exposed to air or other sources of oxygen, such as synovial fluid. This oxidation cycle leads to chain scission and a reduction in the molecular mass of UHMWPE, with a subsequent increased proportion of the crystalline phase through the development of thin crystalline lamellae in the amorphous region (15). These changes have been associated with progressive embrittlement of the polyethylene (58).

The relative proportion of crystalline phase in UHMWPE can be assessed by use of Raman spectroscopy and has been well studied (59-63). Raman spectroscopy has also been utilized in assessment of retrieved UHMWPE orthopaedic components to assess changes in crystallinity (64-66), as well as a number of other physical properties of polyethylene (67). Unlike other methods of assessing crystallinity, this method offers the advantage of being non-destructive to the samples and can allow for further testing by other means. Raman spectroscopy uses a monochromatic light source to illuminate a sample. The photons interact with molecular vibrations within the sample's chemical bonds. If the light is scattered without exchanging energy with these molecular vibrations, the energy is unchanged and is filtered out by the spectrometer. If the light interacts with a molecule and energy is exchanged, the light changes frequency depending on the extent of energy lost or gained in the photon, in order to maintain constant energy in the system. These photons are then scattered onto a detector. Similar to FTIR, various molecular bonds and bond vibrational states create characteristic detectable shifts. The intensity of these frequency shifts at different wavelengths are used to calculate the relative phases of amorphous, crystalline, and intermediate phases within UHMWPE based on the following equations (65):

$$\alpha_c = \frac{I_{1414}}{0.46(I_{1293} + I_{1305})}$$

$$\alpha_a = \frac{I_{1305}}{I_{1293} + I_{1305}}$$

$$\alpha_i = 1 - (\alpha_c + \alpha_a)$$

Where I is the integrated area of each individual Raman band. The 1414 cm^{-1} band represents the orthorhombic crystalline phase, the 1305 cm^{-1} band represents the amorphous phase, and the combination of the 1293 cm^{-1} and 1305 cm^{-1} bands represent an internal intensity standard (59,68).

In the assessment of the impact of *in vivo* time and oxidation on the mechanical properties of HXLPE liner rims, the use of Raman spectroscopy will provide valuable information about changes in polyethylene crystalline content, which is known to increase with oxidation and directly impact the hardness of the material.

4.4 Summary

The advent of HXLPE liners has significantly improved the wear performance of modern total hip arthroplasties, however reports of mechanical failure of these liners, frequently at the liner rim, has raised concerns about the mechanical properties and material degradation *in vivo*. Oxidation has been shown to occur in both annealed and remelted liners, with preferential oxidation in unprotected or unloaded regions such as the implant rim. Oxidation has been shown to decrease the molecular weight of polyethylene, with an associated increase in density and crystallinity. However, there have been no studies collectively assessing changes in mechanical properties, oxidation, and crystallinity at the implant rim.

Depth sensing indentation is a validated method of assessing the hardness of medical grade polyethylene. Hardness of polyethylene increases with increased oxidation. This method will allow direct testing of the hardness of retrieved polyethylene liner rims after *in vivo* service time. Fourier transform infrared spectroscopy is the gold standard method of assessment of polyethylene oxidation after time *in vivo*. Raman spectroscopy allows for a non-destructive assessment of the relative crystallinity of polyethylene and a number of studies have validated this testing strategy.

It is hypothesized that both annealed and remelted retrieved HXLPE liners will demonstrate FTIR spectroscopic evidence of oxidation at the implant rim after extended time *in vivo*, with annealed liners demonstrating more extensive oxidation than remelted

liners. Based on previously published literature, it is predicted that this oxidation will not correlate with the extent of time *in vivo*. Furthermore, it is hypothesized that Raman spectroscopy will reveal a concomitant increase in the crystallinity of the retrieved HXLPE liner rims compared to controls secondary to *in vivo* oxidation, with annealed liners demonstrating a greater increase than remelted liners. Finally, it is hypothesized that microindentation testing will demonstrate that the hardness of retrieved HXLPE liner rims will be increased after *in vivo* time compared to controls, with annealed liners demonstrating a larger increase in hardness than remelted liners. It is anticipated that the results demonstrate a positive correlation between hardness, oxidation index, and crystallinity at the rim of retrieved HXLPE liners with extended *in vivo* service times.

4.5 References

1. Learmonth ID, Young C, Rorabeck C. The operation of the century: total hip replacement. *The Lancet*. 2007;370(9597):1508-1519. doi:10.1016/S0140-6736(07)60457-7
2. Berry DJ, Harmsen WS, Cabanela ME, *et al*. Twenty-five-year survivorship of two thousand consecutive primary charnley total hip replacements: Factors affecting survivorship of acetabular and femoral components. *J Bone Joint Surg Am*. 2002;84(2):171-177.
3. McKellop H, Shen F, Lu B, *et al*. Development of an extremely wear-resistant ultra high molecular weight polyethylene for total hip replacements. *J Orthop Res*. 1999;17(2):157-167. doi:10.1002/jor.1100170203
4. Jacobs CA, Christensen CP, Greenwald AS, *et al*. Clinical performance of highly cross-linked polyethylenes in total hip arthroplasty. *J Bone Joint Surg Am*. 2007;89(12):2779-2786. doi:10.2106/JBJS.G.00043
5. Lachiewicz PF, Soileau ES. Highly Cross-linked Polyethylene Provides Decreased Osteolysis and Reoperation at Minimum 10-Year Follow-Up. *J Arthroplasty*. 2016;31(9):1959-1962. doi:10.1016/j.arth.2016.02.038
6. Kurtz SM, Gawel HA, Patel JD. History and systematic review of wear and osteolysis outcomes for first-generation highly crosslinked polyethylene. *Clin Orthop*. 2011;469(8):2262-2277. doi:10.1007/s11999-011-1872-4
7. Glyn-Jones S, Thomas GER, Garfjeld-Roberts P, *et al*. The John Charnley Award: Highly crosslinked polyethylene in total hip arthroplasty decreases long-term wear: a double-blind randomized trial. *Clin Orthop*. 2015;473(2):432-438. doi:10.1007/s11999-014-3735-2

8. Paxton EW, Inacio MCS, Namba RS, *et al.* Metal-on-conventional polyethylene total hip arthroplasty bearing surfaces have a higher risk of revision than metal-on-highly crosslinked polyethylene: results from a US registry. *Clin Orthop.* 2015;473(3):1011-1021. doi:10.1007/s11999-014-4105-9
9. Paxton E, Cafri G, Havelin L, *et al.* Risk of Revision Following Total Hip Arthroplasty: Metal-on-Conventional Polyethylene Compared with Metal-on-Highly Cross-Linked Polyethylene Bearing Surfaces: International Results from Six Registries. *J Bone Joint Surg Am.* 2014;96(Suppl 1):19-24. doi:10.2106/JBJS.N.00460
10. Hanna SA, Somerville L, McCalden RW, *et al.* Highly cross-linked polyethylene decreases the rate of revision of total hip arthroplasty compared with conventional polyethylene at 13 years' follow-up. *Bone Jt J.* 2016;98-B(1):28-32. doi:10.1302/0301-620X.98B1.36527
11. Gencur SJ, Rimnac CM, Kurtz SM. Fatigue crack propagation resistance of virgin and highly crosslinked, thermally treated ultra-high molecular weight polyethylene. *Biomaterials.* 2006;27(8):1550-1557. doi:10.1016/j.biomaterials.2005.09.010
12. Baker DA, Bellare A, Pruitt L. The effects of degree of crosslinking on the fatigue crack initiation and propagation resistance of orthopedic-grade polyethylene. *J Biomed Mater Res A.* 2003;66(1):146-154. doi:10.1002/jbm.a.10606
13. Muratoglu OK, Bragdon CR. 15 - Highly Cross-Linked and Melted UHMWPE. In: Kurtz SM, ed. *UHMWPE Biomaterials Handbook (Third Edition)*. Oxford: William Andrew Publishing; 2016:264-273. doi:10.1016/B978-0-323-35401-1.00015-6
14. Oral E, Neils AL, Doshi BN, *et al.* Effects of simulated oxidation on the *in vitro* wear and mechanical properties of irradiated and melted highly crosslinked UHMWPE. *J Biomed Mater Res B Appl Biomater.* 2016;104(2):316-322. doi:10.1002/jbm.b.33368
15. Bracco P, Bellare A, Bistolfi A, *et al.* Ultra-High Molecular Weight Polyethylene: Influence of the Chemical, Physical and Mechanical Properties on the Wear Behavior. A Review. *Mater Basel Switz.* 2017;10(7). doi:10.3390/ma10070791
16. Kurtz SM. 25 - Compendium of HXLPEs. In: *UHMWPE Biomaterials Handbook (Third Edition)*. Oxford: William Andrew Publishing; 2016:449-466. doi:10.1016/B978-0-323-35401-1.00025-9
17. MacDonald D, Sakona A, Ianuzzi A, *et al.* Do First-generation Highly Crosslinked Polyethylenes Oxidize *In vivo*? *Clin Orthop Relat Res.* 2011;469(8):2278-2285. doi:10.1007/s11999-010-1728-3
18. Currier BH, Van Citters DW, Currier JH, *et al.* *In vivo* Oxidation in Remelted Highly Cross-Linked Retrievals: *J Bone Joint Surg Am.* 2010;92(14):2409-2418. doi:10.2106/JBJS.I.01006

19. Miura Y, Hasegawa M, Sudo A, *et al.* In-vivo degradation of middle-term highly cross-linked and remelted polyethylene cups: Modification induced by creep, wear and oxidation. *J Mech Behav Biomed Mater.* 2015;51:13-24. doi:10.1016/j.jmbbm.2015.06.028
20. Muratoglu OK, Wannomae KK, Rowell SL, *et al.* Ex vivo stability loss of irradiated and melted ultra-high molecular weight polyethylene. *J Bone Joint Surg Am.* 2010;92(17):2809-2816. doi:10.2106/JBJS.I.01017
21. Rowell SL, Reyes CR, Malchau H, *et al.* In vivo Oxidative Stability Changes of Highly Cross-Linked Polyethylene Bearings: An Ex vivo Investigation. *J Arthroplasty.* 2015;30(10):1828-1834. doi:10.1016/j.arth.2015.05.006
22. Wannomae KK, Bhattacharyya S, Freiberg A, *et al.* In vivo oxidation of retrieved cross-linked ultra-high-molecular-weight polyethylene acetabular components with residual free radicals. *J Arthroplasty.* 2006;21(7):1005-1011. doi:10.1016/j.arth.2005.07.019
23. Currier BH. Evaluation of Oxidation and Fatigue Damage of Retrieved Crossfire Polyethylene Acetabular Cups. *J Bone Joint Surg Am.* 2007;89(9):2023. doi:10.2106/JBJS.F.00336
24. Kurtz SM, Hozack W, Turner J, *et al.* Mechanical Properties of Retrieved Highly Cross-Linked Crossfire Liners After Short-Term Implantation. *J Arthroplasty.* 2005;20(7):840-849. doi:10.1016/j.arth.2005.07.015
25. Kurtz SM, Hozack WJ, Purtill JJ, *et al.* 2006 Otto Aufranc Award Paper: Significance of In vivo Degradation for Polyethylene in Total Hip Arthroplasty: *Clin Orthop.* 2006;453:47-57. doi:10.1097/01.blo.0000246547.18187.0b
26. Kurtz SM, Austin MS, Azzam K, *et al.* Mechanical Properties, Oxidation, and Clinical Performance of Retrieved Highly Cross-Linked Crossfire Liners After Intermediate-Term Implantation. *J Arthroplasty.* 2010;25(4):614-623.e2. doi:10.1016/j.arth.2009.04.022
27. Fung M, Bowsher JG, Van Citters DW. Variation of mechanical properties and oxidation with radiation dose and source in highly crosslinked remelted UHMWPE. *J Mech Behav Biomed Mater.* 2018;82:112-119. doi:10.1016/j.jmbbm.2018.03.005
28. Medel F, Kurtz S, MacDonald D, *et al.* Does cyclic stress play a role in highly crosslinked polyethylene oxidation? *Clin Orthop.* 2015;473(3):1022-1029. doi:10.1007/s11999-015-4153-9
29. Oral E, Ghali BW, Neils A, *et al.* A new mechanism of oxidation in ultrahigh molecular weight polyethylene caused by squalene absorption. *J Biomed Mater Res B Appl Biomater.* 2012;100(3):742-751. doi:10.1002/jbm.b.32507

30. Oral E, Fung M, Rowell SL, *et al.* In-vitro oxidation model for UHMWPE incorporating synovial fluid lipids. *J Orthop Res Off Publ Orthop Res Soc.* January 2018. doi:10.1002/jor.23848
31. Kurtz SM, Oral E. 27 - *In vivo* Oxidation of UHMWPE. In: *UHMWPE Biomaterials Handbook (Third Edition)*. Oxford: William Andrew Publishing; 2016:488-505. doi:10.1016/B978-0-323-35401-1.00027-2
32. Moore KD, Beck PR, Petersen DW, *et al.* Early Failure of a Cross-Linked Polyethylene Acetabular Liner: A Case Report. *J Bone Joint Surg Am.* 2008;90(11):2499-2504. doi:10.2106/JBJS.G.01304
33. Tower SS. Rim Cracking of the Cross-Linked Longevity Polyethylene Acetabular Liner After Total Hip Arthroplasty. *J Bone Joint Surg Am.* 2007;89(10):2212. doi:10.2106/JBJS.F.00758
34. Duffy GP, Wannomae KK, Rowell SL, *et al.* Fracture of a Cross-Linked Polyethylene Liner Due to Impingement. *J Arthroplasty.* 2009;24(1):158.e15-158.e19. doi:10.1016/j.arth.2007.12.020
35. Blumenfeld TJ, McKellop HA, Schmalzried TP, *et al.* Fracture of a Cross-Linked Polyethylene Liner. *J Arthroplasty.* 2011;26(4):666.e5-666.e8. doi:10.1016/j.arth.2010.07.009
36. Hara D, Nakashima Y, Yamamoto T, *et al.* Late failure of annealed highly cross-linked polyethylene acetabular liner. *J Mech Behav Biomed Mater.* 2013;28:206-212. doi:10.1016/j.jmbbm.2013.08.003
37. Ast MP, John TK, Labbisiere A, *et al.* Fractures of a single design of highly cross-linked polyethylene acetabular liners: an analysis of voluntary reports to the United States Food and Drug Administration. *J Arthroplasty.* 2014;29(6):1231-1235. doi:10.1016/j.arth.2013.12.022
38. Furmanski J, Anderson M, Bal S, *et al.* Clinical fracture of cross-linked UHMWPE acetabular liners. *Biomaterials.* 2009;30(29):5572-5582. doi:10.1016/j.biomaterials.2009.07.013
39. Waewsawangwong W, Goodman SB. Unexpected Failure of Highly Cross-Linked Polyethylene Acetabular Liner. *J Arthroplasty.* 2012;27(2):323.e1-323.e4. doi:10.1016/j.arth.2011.04.010
40. Wernlé JD, Gilbert JL. Micromechanics of shelf-aged and retrieved UHMWPE tibial inserts: indentation testing, oxidative profiling, and thickness effects. *J Biomed Mater Res B Appl Biomater.* 2005;75(1):113-121. doi:10.1002/jbm.b.30285
41. Gilbert JL, Wernle JD. 40 - Nano- and Microindentation Testing of UHMWPE. In: Kurtz SM, ed. *UHMWPE Biomaterials Handbook (Third Edition)*. Oxford: William Andrew Publishing; 2016:772-785. doi:10.1016/B978-0-323-35401-1.00040-5

42. Yovanovich MM. Micro and Macro Hardness Measurements, Correlations, and Contact Models. Presented at the: 44th AIAA Aerospace Sciences Meeting and Exhibit; January 9, 2006; Reno, NV.
http://www.mhtl.uwaterloo.ca/pdf_papers/mhtl06-2.pdf.
43. Gilbert JL, Merkhani I. Rate effects on the microindentation-based mechanical properties of oxidized, crosslinked, and highly crystalline ultrahigh-molecular-weight polyethylene. *J Biomed Mater Res A*. 2004;71(3):549-558.
doi:10.1002/jbm.a.30196
44. Medel FJ, Rimnac CM, Kurtz SM. On the Assessment of Oxidative and Microstructural Changes After *In Vivo* Degradation of Historical UHMWPE Knee Components by Means of Vibrational Spectroscopies and Nanoindentation. *J Biomed Mater Res A*. 2009;89(2):530-538. doi:10.1002/jbm.a.31992
45. Roy ME. Influence of cross linking and oxidation on the microstructural mechanical properties of UHMWPE. *Mat Res Soc Symp Proc*. 2005;847.
46. ISO 14577-1:2015 - Metallic materials -- Instrumented indentation test for hardness and materials parameters -- Part 1: Test method.
<https://www.iso.org/standard/56626.html>. Accessed June 20, 2018.
47. Slouf M, Vacková T, Nevořalová M, *et al*. Micromechanical properties of one-step and sequentially crosslinked UHMWPEs for total joint replacements. *Polym Test*. 2014;41. doi:10.1016/j.polymertesting.2014.12.003
48. ASTM E384-17, Standard Test Method for Microindentation Hardness of Materials. doi:10.1520/E0384-17
49. Gilbert JL, Cumber J, Butterfield A. Surface micromechanics of ultrahigh molecular weight polyethylene: Microindentation testing, crosslinking, and material behavior. *J Biomed Mater Res*. 2002;61(2):270-281. doi:10.1002/jbm.10143
50. Zhou J, Chakravartula A, Pruitt L, *et al*. Tribological and Nanomechanical Properties of Unmodified and Crosslinked Ultra-High Molecular Weight Polyethylene for Total Joint Replacements. *J Tribol*. 2004;126(2):386-394.
doi:10.1115/1.1611511
51. Kurtz SM, MacDonald DW, Mont MA, *et al*. Retrieval analysis of sequentially annealed highly crosslinked polyethylene used in total hip arthroplasty. *Clin Orthop*. 2015;473(3):962-971. doi:10.1007/s11999-014-4113-9
52. Kurtz SM, Muratoglu OK, Buchanan FJ, *et al*. Interlaboratory studies to determine optimal analytical methods for measuring the oxidation index of UHMWPE. *Biomaterials*. 2001;22(21):2875-2881. doi:10.1016/S0142-9612(01)00033-3

53. Kurtz SM, Muratoglu OK, Gsell R, *et al.* Interlaboratory validation of oxidation-index measurement methods for UHMWPE after long-term shelf aging. *J Biomed Mater Res.* 2002;63(1):15-23.
54. Kurtz SM, Muratoglu OK, Buchanan F, *et al.* Interlaboratory reproducibility of standard accelerated aging methods for oxidation of UHMWPE. *Biomaterials.* 2001;22(13):1731-1737.
55. Spiegelberg S, Kozak A, Braithwaite G. 29 - Characterization of Physical, Chemical, and Mechanical Properties of UHMWPE. In: Kurtz SM, ed. *UHMWPE Biomaterials Handbook (Third Edition)*. Oxford: William Andrew Publishing; 2016:531-552. doi:10.1016/B978-0-323-35401-1.00029-6
56. Sun DC, Halleck A, Schmidig G, *et al.* Fourier transform infrared (FTIR) oxidation analysis of UHMWPE implants: Possible contamination from synovial fluid and serum. *Charact Prop Ultra-High Mol Weight Polyethyl.* 1998;1307:39-45. doi:10.1520/STP11909S
57. Currier BH, Currier JH, Mayor MB, *et al.* *In vivo* oxidation of gamma-barrier-sterilized ultra-high-molecular-weight polyethylene bearings. *J Arthroplasty.* 2007;22(5):721-731. doi:10.1016/j.arth.2006.07.006
58. Kurtz SM, Zagorski M. 3 - Packaging and Sterilization of UHMWPE. In: *UHMWPE Biomaterials Handbook (Third Edition)*. Oxford: William Andrew Publishing; 2016:21-32. doi:10.1016/B978-0-323-35401-1.00003-X
59. Strobl GR, Hagedorn W. Raman spectroscopic method for determining the crystallinity of polyethylene. *J Polym Sci Polym Phys Ed.* 16(7):1181-1193. doi:10.1002/pol.1978.180160704
60. Rull F, Prieto AC, Casado JM, *et al.* Estimation of crystallinity in polyethylene by Raman spectroscopy. *J Raman Spectrosc.* 24(8):545-550. doi:10.1002/jrs.1250240813
61. Taddei P, Affatato S, Fagnano C, *et al.* Vibrational spectroscopy of ultra-high molecular weight polyethylene hip prostheses: influence of the sterilisation method on crystallinity and surface oxidation. *J Mol Struct.* 2002;613(1):121-129. doi:10.1016/S0022-2860(02)00141-2
62. Bertoluzza A, Fagnano C, Rossi M, *et al.* Micro-Raman spectroscopy for the crystallinity characterization of UHMWPE hip cups run on joint simulators. *J Mol Struct.* 2000;521(1):89-95. doi:10.1016/S0022-2860(99)00427-5
63. Puppulin L, Kumakura T, Yamamoto K, *et al.* Structural profile of ultra-high molecular weight polyethylene in acetabular cups worn on hip simulators characterized by confocal Raman spectroscopy. *J Orthop Res.* 29(6):893-899. doi:10.1002/jor.21331

64. Tone S, Hasegawa M, Pezzotti G, *et al.* Effect of e-beam sterilization on the *in vivo* performance of conventional UHMWPE tibial plates for total knee arthroplasty. *Acta Biomater.* 2017;55:455-465. doi:10.1016/j.actbio.2017.03.040
65. Puppulin L, Miura Y, Casagrande E, *et al.* Validation of a protocol based on Raman and infrared spectroscopies to nondestructively estimate the oxidative degradation of UHMWPE used in total joint arthroplasty. *Acta Biomater.* 2016;38:168-178. doi:10.1016/j.actbio.2016.04.040
66. Puppulin L, Negra SD, Sugano N, *et al.* Surface modifications induced by in-vitro wear and oxidation on γ -irradiated UHMWPE hip liners belonging to different commercial generations. *J Mech Behav Biomed Mater.* 2016;53:414-426. doi:10.1016/j.jmbbm.2015.08.035
67. Pezzotti G. Raman spectroscopy of biomedical polyethylenes. *Acta Biomater.* 2017;55:28-99. doi:10.1016/j.actbio.2017.03.015
68. Glotin M, Mandelkern L. A Raman spectroscopic study of the morphological structure of the polyethylenes. *Colloid Polym Sci.* 1982;260(2):182-192. doi:10.1007/BF01465438

Chapter 5

5 A Comparison of Hardness Changes Between Retrieved Highly Cross-Linked Polyethylene Bearings with Different Free Radical Stabilization Techniques

5.1 Introduction

Since its introduction as a bearing surface in total hip arthroplasty (THA), Ultra-high molecular weight polyethylene (UHMWPE) has been the bearing surface of choice in modern THA designs to this day. However, the success of conventional UHMWPE has been limited by the long-term material wear, which can lead to instability, osteolysis, aseptic implant loosening and need for revision surgery (1-3). Furthermore, demand for THA in young and active patients has also increased the demand for a more durable bearing surface (4). These factors expedited the development of highly cross-linked polyethylene (HXLPE) bearing surfaces.

UHMWPE is a semi-crystalline material containing crystalline, amorphous, and tertiary phases. The crystalline phase is characterized by well organized, densely packed lamellae whereas the amorphous phase is fairly disorganized (5). HXLPE is produced by introducing gamma or electron beam irradiation to UHMWPE leading to cleavage of the C-C and C-H covalent bonds which form highly reactive free radicals. In an inert environment, free radicals in the amorphous regions can recombine to form cross-links, whereas those formed in the crystalline region remain trapped (6). These remnant free radicals can persist and then react with oxygen to form alkyl free radicals, leading to a self-perpetuating oxidation process that leads to significant material degradation and changes in the mechanical properties of the implant (7-9).

First generation HXLPE implants undergo a thermal free radical stabilization process to reduce or eliminate residual free radicals through post-irradiation remelting or annealing. When polyethylene is remelted, the rigid crystalline regions are able to mobilize and free radicals present in these regions can reconnect or cross-link, leaving undetectable levels of free radicals (10). The ability of polyethylene chains to mobilize and form into crystalline lamellae is compromised secondary to the presence of crosslinks and therefore

overall crystallinity is reduced after recrystallization (11) . As the strength of UHMWPE is dependent on its relative crystallinity, this reduction in overall crystallinity in remelted HXLPE results in decreased ultimate strength, yield strength, and fatigue resistance (7,11). By comparison, when polyethylene is annealed, not all crystalline lamellae are melted and, as such, not all free radicals are stabilized. Therefore, the relative crystallinity of annealed HXLPE remains nearly unchanged, as do the mechanical properties (12,13). Following the initial attempts to mitigate oxidation through the annealing process, a second generation of HXLPE implants has utilized a sequential annealing process to further reduce the amount of residual free radicals (14). Although differences exist in the physical and mechanical properties of first generation HXLPE liners based on the thermal free radical stabilization process, both techniques have clinical and *in vitro* studies confirming a significant reduction in wear rates compared to conventional UHMWPE, along with reduced osteolysis and wear-related revision surgery rates (15-21).

While clinical performance and wear characteristics have been promising, there have been a number of reports of mechanical failure of HXLPE acetabular liners, particularly at the implant rim (22-29). Although the prevalence of HXLPE implant failure resulting from rim fracture is low at this time, increased implant longevity (due to improved wear characteristics) along with the implantation of an increasing volume of these liners in younger higher-demand patients necessitates the investigation of the potential *in vivo* changes in the mechanical properties of this material. In general, these infrequent mechanical failures have largely been considered multifactorial. However, a number of retrieval studies have found evidence of *in vivo* oxidation of first and second generation annealed HXLPE acetabular liners, in particular at the implant rim (30-35). Similarly, *in vivo* oxidation of remelted polyethylene has been detected despite a near absence of detectable free radicals (30,36-39). Furthermore, oxidation at the implant rim has been shown to correlate with *in vivo* time in annealed, but not in remelted liners. Though the mechanical properties of retrieved HXLPE liners has been assessed on the articular surface (30,33,34), mechanical properties of the implant rim after *in vivo* exposure have not been well described. In addition, most retrieval studies have a limited number of

implants with long *in-vivo* times, which may limit the ability to assess long term oxidation and subsequent mechanical changes.

The purpose of this study is to explore the differences in the mechanical properties of HXLPE acetabular liner rims after extended time *in vivo* between liners manufactured with different free radical stabilization techniques. In addition, an assessment of changes in mechanical properties of acetabular liners after extended *in vivo* time compared to never implanted controls for liners manufactured with different free radical stabilization techniques will be performed. Vickers microhardness, a form of depth sensing indentation (DSI), will be utilized in this study to assess acetabular liner rim mechanical properties. Hardness has been shown to positively correlate with oxidation in UHMWPE implants (40,41). Oxidation leads to an increased proportion of the crystalline phase, where the end result is an increase in material brittleness that is associated with increased risk of fatigue damage (8,42). Thus, if oxidation of the implant rim is occurring *in vivo*, an increase in measured hardness with prolonged *in vivo* time would be expected. It is hypothesized that single and sequentially annealed liner rims will demonstrate a greater increase in hardness with *in vivo* service time than remelted liners.

5.2 Materials and Methods

A review of the implant retrieval laboratory (IRL) database was performed to obtain a list of available HXLPE acetabular liners with *in vivo* times greater than 4.5 years.

Institutional review board approval was obtained for access to the retrieved implants and associated patient data. All retrieved implants underwent an identical sanitation and storage protocol including cleansing in a 10% bleach solution, fixation in 10% formalin solution, and storage wrapped in gauze in a closed cardboard box stored in a clean, dry and well-ventilated storage room at ambient temperature in room air. Inclusion criteria included implants with *in vivo* time greater than 4.5 years, implants having undergone thermal free radical stabilization during manufacturing, ability to identify the specific HXLPE material of the implant, and an implant rim without significant damage from removal with a suitable testing surface. Exclusion criteria included *in vivo* time under 4.5 years, conventional UHMWPE, implants lacking appropriate identifiers to confirm the material, and implant rims with significant damage from removal and/or lacking a

suitable rim surface for testing. A total of 55 implants were identified that met inclusion criteria (table 5-1). Liners were divided into three groups based on free radical stabilization technique: remelted, single annealed, or sequential annealed. Patient gender, age, indication for revision, *in vivo* time and *ex vivo* time for each implant is provided in appendix A. A total of 13 never implanted control liners were tested to assess for changes from baseline properties after *in vivo* time. Control liners were obtained directly from implant manufacturers and maintained in air impermeable post-manufacturing packaging until the time of sample preparation and testing. The distribution of control liners by manufacturer and HXLPE type can be found in table 5-1.

Microindentation hardness testing was performed along the rim surface of each acetabular liner according to ASTM E384 using a Micromet II Vickers microhardness tester (Buehler Ltd, Lake Bluff, IL). Testing was focused along the rim region only to do the requirements of a flat surface for testing accuracy and the specific interest in rim mechanical properties. Testing was performed in an independent laboratory in a blinded fashion by a single operator under identical testing conditions. Calibration was performed using a standard steel carbon sample with a known Vickers hardness number of 335-350 kgf/mm². Each liner was mounted into the tester fixed in a plaster mold. A square-based diamond indenter was used to apply a load of 0.0254 kgf into the flat surface of the rim for a 10 second dwell time. The diagonal lengths (d_1 and d_2) of the resultant indentation were measured using the micro-ruler on the machine's microscope, measured at 40x magnification (figure 5-1). Each rim was tested with 10 to 16 indentations. The Vickers hardness (HV) for each sample was calculated using the following equation:

$$HV = 1.8544 \frac{F}{d^2}$$

Where d is the mean diagonal length of the indentation in mm ($d=(d_1+d_2)/2$). A mean Vickers hardness and standard deviation was calculated for each sample.

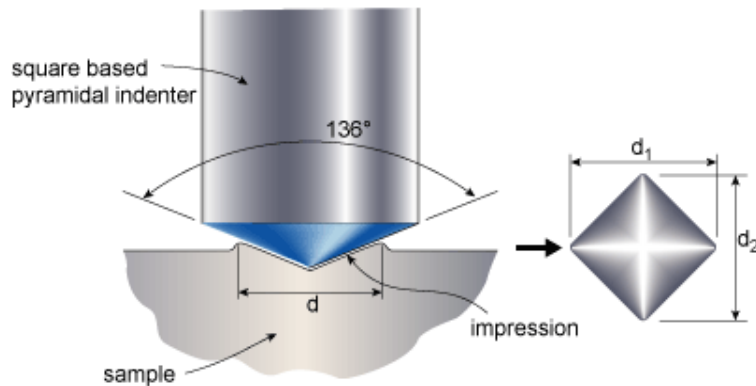

Figure 5-1 - Vickers Microindentation with a square-based diamond tip indenter. The Indenter is loaded into the implant rim surface with a predefined loading force and dwell time, leaving a residual surface indentation. The resultant diagonal lengths (d_1 and d_2) can be measured under an optical microscope. (Courtesy TWI Ltd. Hardness Testing Part 1 - Job Knowledge 74, <https://www.twi-global.com/technical-knowledge/job-knowledge/hardness-testing-part-1-074>, (accessed 24 June, 2018))

A comparison of sample characteristics based on thermal free radical stabilization group was performed using SPSS (Version 25, IBM Corp, Armonk, NY). A post hoc power analysis was performed using G*Power (Version 3.1.9.3, Faul, Erdfelder, Lang, and Buchner, 2009). Independent sample t -test and analysis of covariance were used for normal data distributions. Spearman's rank-order correlations, Mann-Whitney U and Kruskal-Wallis H tests were used for non-normal data distributions.

Table 5-1 - Summary of retrieval and control implant data

<i>Manufacturer</i>	<i>Depuy</i>	<i>Depuy</i>	<i>Zimmer</i>	<i>Smith & Nephew</i>	<i>Stryker</i>	<i>Stryker</i>
<i>HXLPE Material</i>	AltrX	Marathon	Longevity	XLPE	Crossfire	X3
<i>N (retrievals)</i>	3	3	7	10	16	16
<i>N (controls)</i>	1	2	2	3	2	3
<i>Stabilization Method</i>	Remelted	Remelted	Remelted	Remelted	Single Annealed	Sequentially Annealed
<i>Stock Material</i>	GUR1020	GUR1050	GUR1050	GUR1050	GUR1050	GUR1020

5.3 Results

Average age at the time of revision was 69 years and 60% of patients were male. Indication for revision surgery were infection (22.6%), aseptic loosening (18.9%), instability (18.9%), periprosthetic fracture (15.1%), revision of a recalled implant (9.4%), recalcitrant pain (7.5%), implant malposition (5.7%), and trunnionosis (1.9%).

In vivo and *ex vivo* times for each thermal stabilization group are presented in table 5-2. There was no statistically significant difference between groups for *in vivo* time ($p=.184$) and *ex vivo* time ($p=.484$).

Table 5-2 - *In vivo* and *Ex vivo* Times (years) by thermal stabilization

<i>Thermal Stabilization</i>	<i>Remelted</i> (<i>n</i> =23)	<i>Single Annealed</i> (<i>n</i> =16)	<i>Sequentially Annealed</i> (<i>n</i> =16)
<i>In vivo Time, Mean</i>	7.91	7.92	6.73
<i>In vivo Time, Range</i>	4.60 - 13.74	4.76 - 14.01	5.17 - 11.88
<i>Ex vivo Time, Mean</i>	3.90	4.00	2.52
<i>Ex vivo Time, Range</i>	0.25 - 11.60	0.33 - 8.61	0.69 - 5.09

Correlations of Vickers hardness with *in vivo* and *ex vivo* time for each thermal stabilization group are presented in table 5-3. No correlation was found between *in vivo* or *ex vivo* time and Vickers hardness in the single and sequentially annealed groups. No statistically significant correlation was found between *in vivo* time and Vickers hardness in the remelted group (figure 5-2), however a statistically significant correlation ($\rho =.520$, $p=.011$) was found between *ex vivo* time and Vickers hardness in the remelted group (figure 5-3).

Table 5-3 - Correlation between Vickers Hardness (HV), *in vivo* and *ex vivo* time

	<i>Remelted</i> (<i>n</i> =23)	<i>Single</i> <i>Annealed</i> (<i>n</i> =16)	<i>Sequentially</i> <i>Annealed</i> (<i>n</i> =16)
Hardness and <i>In vivo</i> Time			
Spearman's Rho (ρ)	-.250	-.047	-.303
<i>p</i> -value	.250	.863	.255
Hardness and <i>Ex vivo</i> Time			
Spearman's Rho (ρ)	.520	.094	.253
<i>p</i> -value	.011	.729	.345

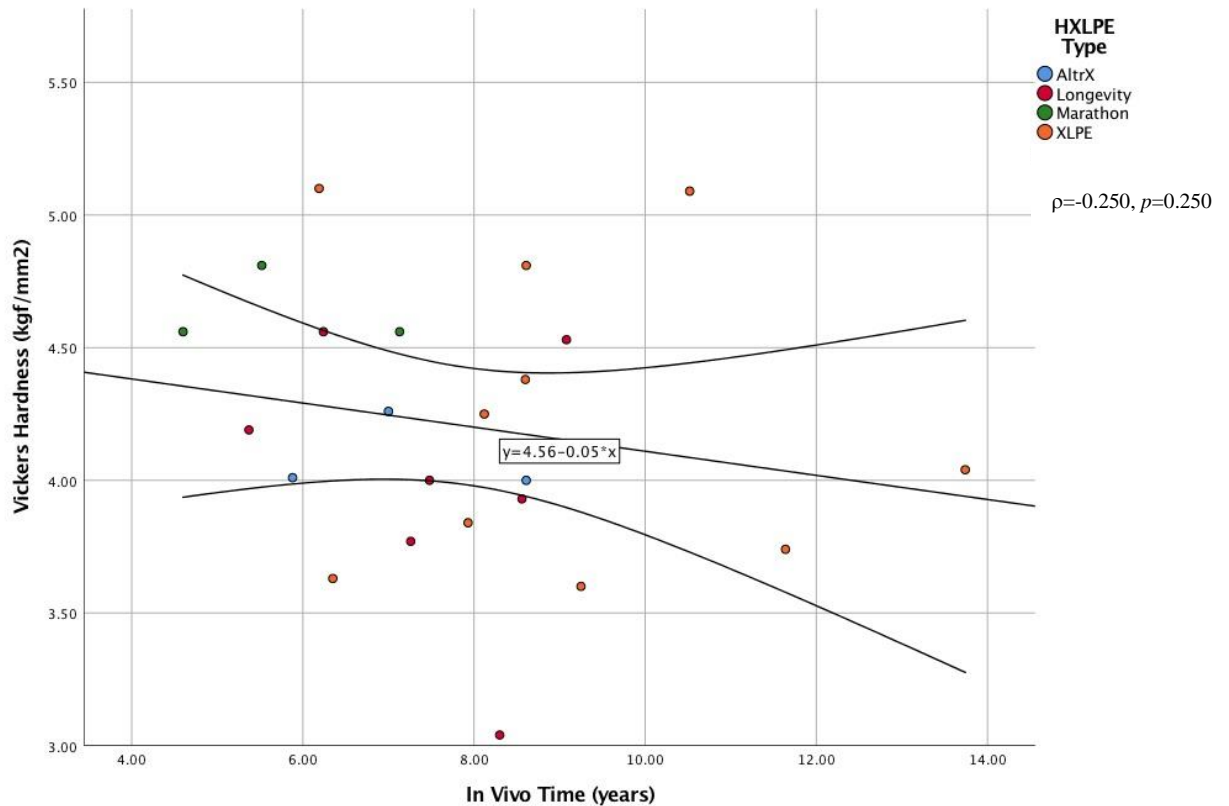

Figure 5-2 - No statistically significant correlation was noted between Vickers hardness and *in vivo* time for remelted HXLPE liner rims. No individual HXLPE group disproportionately impacted the correlation results.

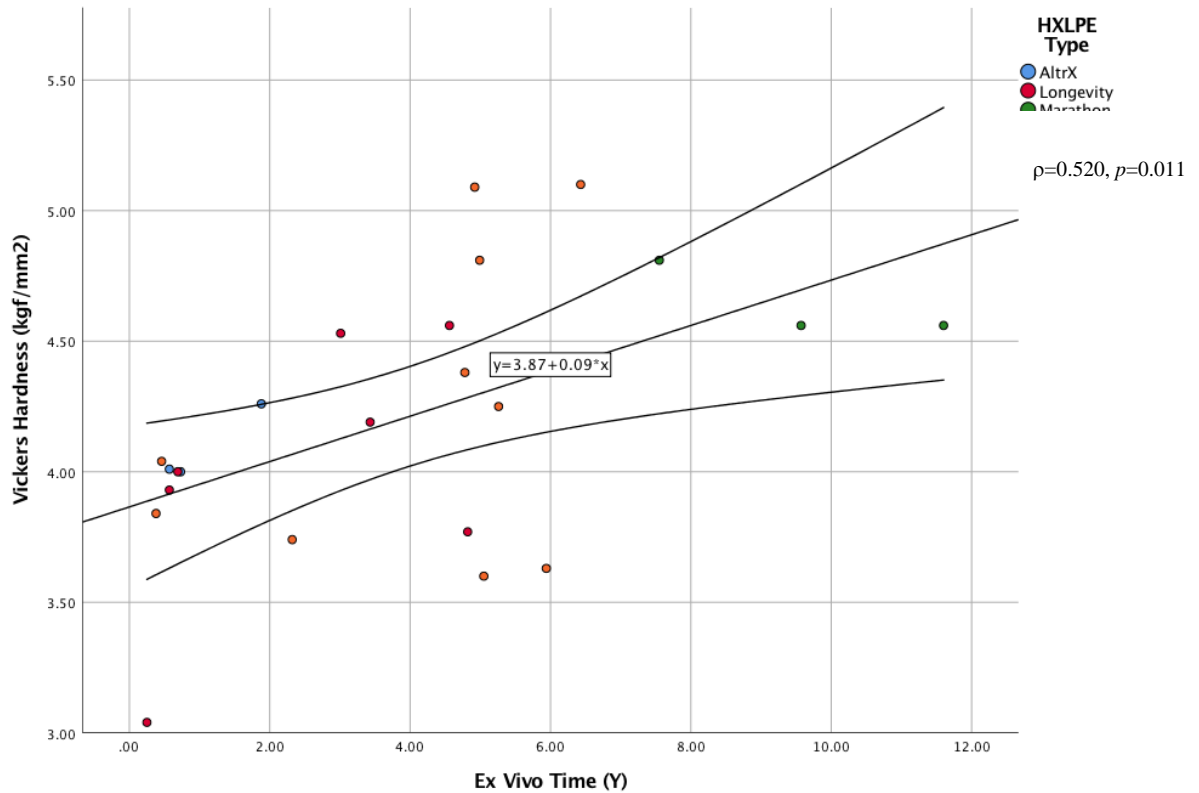

Figure 5-3 – A statistically significant correlation was noted between Vickers hardness and *ex vivo* time for remelted HXLPE liner rims. No individual HXLPE group disproportionately impacted the correlation results.

Analysis of covariance with *ex vivo* time as a covariate was performed to assess for differences in Vickers hardness in retrieved liners by their thermal treatment. There was a statistically significant difference in Vickers hardness between the free radical stabilization groups ($p < .0005$, $\eta^2 = 0.322$). Post hoc analysis revealed that Vickers hardness was statistically significantly lower in the retrieved remelted group compared to both the single annealed group ($p = .001$) and sequentially annealed group ($p < .0005$). There was not a statistically significant difference in hardness between retrieved single and sequentially annealed groups ($p = 1$).

Post hoc power analysis was performed to determine if the sample size was adequate to detect a difference in hardness between groups. Based on the calculated effect ($\eta^2 =$

0.322), total sample size of 55 and a significance level of 5%, the calculated power for this sample analysis is 99.6%.

Hardness of retrieval liners was compared to control liners for changes in hardness from baseline properties (figure 5-4). For remelted liners, there was a statistically significant increase in hardness from control to retrieved liners by 0.40 kgf/mm^2 (95% CI 0.14 – 0.68, $p=.007$). One statistical outlier was noted in the remelted control liner group. However, the statistical significance of the difference between the remelted control and retrieval groups remained when both the outlier was excluded and when nonparametric analysis was performed. No hardness difference was seen between control and retrieved single annealed or sequentially annealed liners.

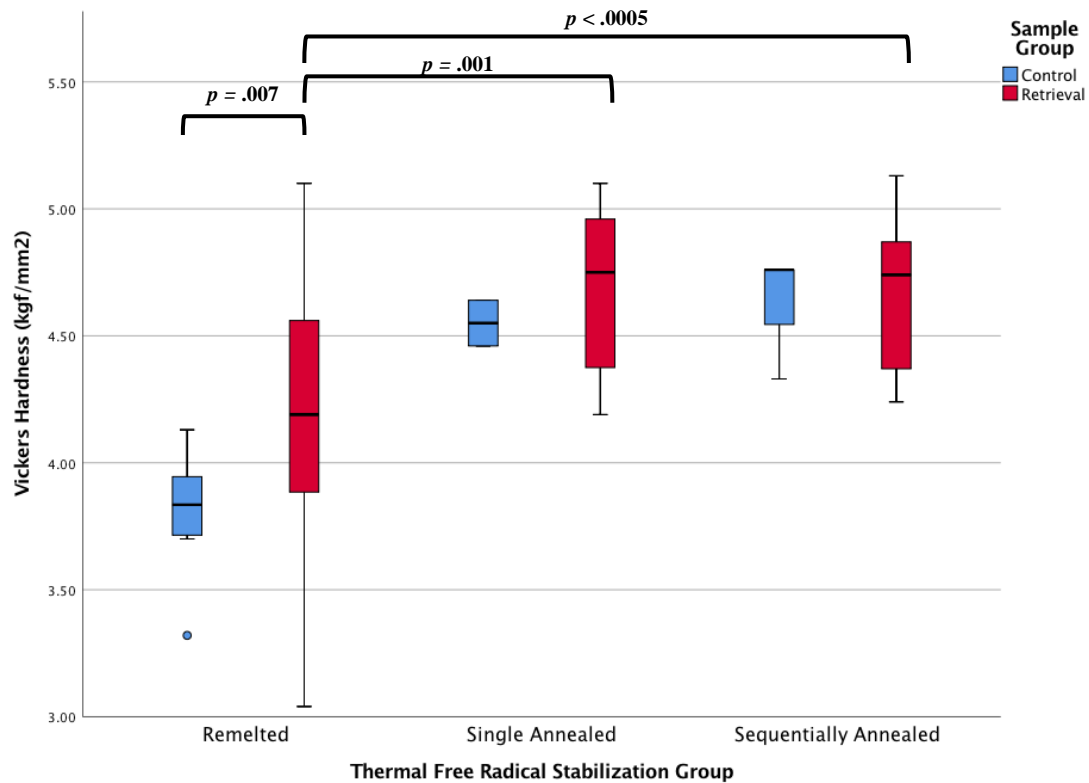

Figure 5-4 - Comparison of hardness values for control and retrieved liner rims grouped according to their thermal stabilization. Note that statistically significant differences were found in Vickers hardness between retrieved remelted liner rims compared to both single and sequentially annealed liner rims, as well as between remelted control and retrieved liner rims.

5.4 Discussion

With HXLPE well into the second decade of use in THA, assessment of this material after long term implantation is important to understand its clinical performance and identify potential concerns. The implant rim is an area of particular interest given the numerous reports of HXLPE liner failures at the implant rim (22-29). Mechanical properties of retrieved HXLPE liner rims has not been well characterized in the literature. With an increasing volume of utilization and increased implant longevity, it is important to characterize any implant mechanical property changes that may with *in vivo* use.

The results revealed a lower hardness in both the retrieved and control remelted liners compared to single or sequentially annealed liners. It has been demonstrated that the crystallinity of remelted liners is lower than that of annealed liners (12). As the strength of UHMWPE is dependent on its relative crystallinity, remelted HXLPE demonstrates decreased ultimate strength, yield strength, and fatigue resistance compared to conventional UHMWPE (7,11,12). The hardness results within the control and retrieval groups are consistent with the differences in crystallinity of the different HXLPE materials.

The most significant finding of this study is that the retrieved remelted HXLPE liner rims demonstrated an increase in hardness after *in vivo* time when compared to never implanted control liners, after accounting for *ex vivo* time. In contrast, no significant change in the hardness of the implant rim for single annealed and sequentially annealed liners was found under the same conditions. Given that hardness has been shown to correlate with oxidation (40,41), an increase in measured hardness with prolonged *in vivo* time in implants prone to *in vivo* oxidation would be expected. These findings are surprising given the higher prevalence of rim oxidation in annealed liners as found in prior studies, as well as the association known to exist between hardness and oxidation as noted above. In annealed HXLPE liners, oxidation has been shown to occur after *in vivo* exposure with the highest levels detected at the implant rim, with greater oxidation occurring in single compared to sequentially annealed liner rims (30-35,43). Though the rim mechanical properties have not been well characterized, annealed liners do demonstrate evidence of rim damage after *in vivo* time (32,34,43). Single annealed liners

have demonstrated damage such as delamination consistent with material fatigue, whereas sequentially annealed liners demonstrated evidence of burnishing or scratching without evidence of fatigue damage (43). Remelted HXLPE liners have also shown evidence of *in vivo* oxidation despite previously being thought to be oxidation resistant (30,36-39). However, rim oxidation has generally been significantly lower in retrieved remelted and sequentially annealed liners than single annealed liners. MacDonald *et al* (30) assessed 80 retrieved annealed HXLPE liners with *in vivo* time ranging from 0 – 10.3 years and 160 retrieved remelted HXLPE liners with *in vivo* time ranging from 0 to 11.4 years. For annealed implants, the average oxidation index (OI) was 0.5 ± 0.4 at the articular surface and 3.7 ± 3.1 at the rim. The ultimate load at the articular surface of the implant demonstrated a negative correlation with *in vivo* time at both the superior ($\rho = -0.239$; $p = .037$) and inferior ($\rho = -0.341$; $p = .003$) surfaces, with a decrease of approximately 10 – 15% after 10 years *in vivo* time. For the remelted liners, the average OI at both the rim and articular surface was 0.1 ± 0.1 , with positive correlation to *in vivo* time for the articular surface ($\rho = 0.205$, $p = .01$), but not the rim ($\rho = 0.019$, $p = 0.816$). Articular surface mechanical properties were not correlated with *in vivo* time ($\rho = 0.045$; $p = 0.590$). Thus, oxidation and subsequently hardness would be anticipated to be greater in the retrieved annealed liners rather than the remelted liners.

The increase in hardness of retrieved remelted HXLPE liners relative to controls observed in this study may be due to the compromised mechanical properties of remelted HXLPE relative to annealed HXLPE, exacerbated by even low levels of oxidation and subsequent mechanical property degradation. Prior studies on conventional UHMWPE demonstrated that $OI > 1$ can impair mechanical behavior, with $OI > 3$ considered “critical oxidation” where mechanical integrity is considered completely compromised (32,44). However, the threshold for oxidation to impact the mechanical properties of HXLPE may be much lower. In studies assessing the role of radiation and lipid absorption in oxidation of HXLPE, Oral *et al* (6,45) found that the mechanical properties of remelted HXLPE became compromised at much lower oxidation indices than found in conventional UHMWPE. With OI values as low as 0.1, ultimate tensile strength and cross-link density were shown to decrease rapidly along with an associated increase in modulus of elasticity. They proposed that tie chains and the amorphous-crystalline

linkages underwent oxidative degradation accounting for the sharp decrease in the ultimate tensile strength with increasing oxidation, and that the increase in the elastic modulus with the degradation of crosslink density occurred due to short chain recrystallization secondary to chain scission (6). Similarly, Fung *et al* (46) demonstrated the critical oxidation levels for numerous mechanical properties, including ultimate tensile strength, to be less than 1 in remelted HXLPE liners, with the critical oxidation value even lower for lesser levels of initial implant radiation. Given these findings, it is possible that even low levels of *in vivo* oxidation along the implant rim in remelted HXLPE liners could compromise the mechanical properties further and account for the differences found in this study.

This study has several strengths. This study utilized the use of a relatively simple and non-destructive method of mechanically testing THA liner rims using a microindentation technique. This technique has previously been validated (47) in HXLPE liner rim testing. By testing from the flat rim surface, alterations in the implant surface due to sample preparation and damage to the liners prohibiting future study was avoided. This study was appropriately powered to detect a difference in hardness in the retrieved liner rim hardness values and between retrieved and control remelted liner rim hardness values. Another strength was that this study included samples with a greater average *in vivo* time than current retrieval studies, thus allowing for a long-term assessment of the impact of *in vivo* use on implant mechanical properties. This study also has some limitations. This study was limited to the assessment of hardness of HXLPE liner rims and do not directly assess for oxidation, crystallinity, or other mechanical properties that may be impacted by *in vivo* time. Due to accessibility, there were a limited number of controls for the single and sequentially annealed liners, limiting the statistical analysis in these cohorts. Furthermore, indentation testing was only performed at the rim surface, thus potentially limiting the ability to assess for hardness changes within the material where subsurface oxidation has been demonstrated to be greatest. In addition, an assessment of rim mechanical properties was not performed based on evidence of fatigue damage, impingement or liner orientation. *Ex vivo* time was not directly controlled for in sample selection. However, *ex vivo* time was accounted for in the statistical analysis. Remelted liners came from multiple manufacturers with differences in radiation doses which has

been shown to influence oxidative stability and mechanical properties in *in vitro* studies (6,46).

It has been demonstrated in this study that after extended *in vivo* time, remelted HXLPE liner rims demonstrate a lower baseline hardness than single and sequentially annealed liner rims. Remelted liners rims increase in hardness with *in vivo* service, whereas single and sequentially annealed liner rim hardness remains relatively unchanged, when compared to control specimens. Given the reports of liner rim fractures in remelted HXLPE, these findings warrant further investigation. Assessment of rim microstructural properties and *in vivo* oxidation after extended *in vivo* time may elucidate the cause of these mechanical property changes and provide insight into the risk factors for rim fracture with long-term use.

5.5 References

1. Willert HG, Bertram H, Buchhorn GH. Osteolysis in alloarthroplasty of the hip. The role of ultra-high molecular weight polyethylene wear particles. *Clin Orthop*. 1990;(258):95-107.
2. Cooper RA, McAllister CM, Borden LS, *et al*. Polyethylene debris-induced osteolysis and loosening in uncemented total hip arthroplasty. A cause of late failure. *J Arthroplasty*. 1992;7(3):285-290.
3. Ingham E, Fisher J. Biological reactions to wear debris in total joint replacement. *Proc Inst Mech Eng [H]*. 2000;214(1):21-37. doi:10.1243/0954411001535219
4. Ravi B, Croxford R, Reichmann WM, *et al*. The changing demographics of total joint arthroplasty recipients in the United States and Ontario from 2001 to 2007. *Best Pract Res Clin Rheumatol*. 2012;26(5):637-647. doi:10.1016/j.berh.2012.07.014
5. Pezzotti G. Raman spectroscopy of biomedical polyethylenes. *Acta Biomater*. 2017;55:28-99. doi:10.1016/j.actbio.2017.03.015
6. Oral E, Neils AL, Doshi BN, *et al*. Effects of simulated oxidation on the *in vitro* wear and mechanical properties of irradiated and melted highly crosslinked UHMWPE. *J Biomed Mater Res B Appl Biomater*. 2016;104(2):316-322. doi:10.1002/jbm.b.33368
7. Bracco P, Bellare A, Bistolfi A, *et al*. Ultra-High Molecular Weight Polyethylene: Influence of the Chemical, Physical and Mechanical Properties on the Wear Behavior. A Review. *Mater Basel Switz*. 2017;10(7). doi:10.3390/ma10070791

8. Kurtz SM, Zagorski M. 3 - Packaging and Sterilization of UHMWPE. In: *UHMWPE Biomaterials Handbook (Third Edition)*. Oxford: William Andrew Publishing; 2016:21-32. doi:10.1016/B978-0-323-35401-1.00003-X
9. Costa L, Bracco P. 26 - Mechanisms of Cross-Linking, Oxidative Degradation, and Stabilization of UHMWPE. In: Kurtz SM, ed. *UHMWPE Biomaterials Handbook (Third Edition)*. Oxford: William Andrew Publishing; 2016:467-487. doi:10.1016/B978-0-323-35401-1.00026-0
10. Muratoglu OK, Bragdon CR, O'Connor DO, *et al.* A novel method of cross-linking ultra-high-molecular-weight polyethylene to improve wear, reduce oxidation, and retain mechanical properties. Recipient of the 1999 HAP Paul Award. *J Arthroplasty*. 2001;16(2):149-160. doi:10.1054/arth.2001.20540
11. Muratoglu OK, Bragdon CR. 15 - Highly Cross-Linked and Melted UHMWPE. In: Kurtz SM, ed. *UHMWPE Biomaterials Handbook (Third Edition)*. Oxford: William Andrew Publishing; 2016:264-273. doi:10.1016/B978-0-323-35401-1.00015-6
12. Atwood SA, Van Citters DW, Patten EW, *et al.* Tradeoffs amongst fatigue, wear, and oxidation resistance of cross-linked ultra-high molecular weight polyethylene. *J Mech Behav Biomed Mater*. 2011;4(7):1033-1045. doi:10.1016/j.jmbbm.2011.03.012
13. Pruitt LA, Ansari F, Kury M, *et al.* Clinical trade-offs in cross-linked ultrahigh-molecular-weight polyethylene used in total joint arthroplasty. *J Biomed Mater Res B Appl Biomater*. 2013;101B. doi:10.1002/jbm.b.32887
14. Dumbleton JH, D'Antonio JA, Manley MT, *et al.* The basis for a second-generation highly cross-linked UHMWPE. *Clin Orthop*. 2006;453:265-271. doi:10.1097/01.blo.0000238856.61862.7d
15. Jacobs CA, Christensen CP, Greenwald AS, *et al.* Clinical performance of highly cross-linked polyethylenes in total hip arthroplasty. *J Bone Joint Surg Am*. 2007;89(12):2779-2786. doi:10.2106/JBJS.G.00043
16. Lachiewicz PF, Soileau ES. Highly Cross-linked Polyethylene Provides Decreased Osteolysis and Reoperation at Minimum 10-Year Follow-Up. *J Arthroplasty*. 2016;31(9):1959-1962. doi:10.1016/j.arth.2016.02.038
17. Kurtz SM, Gawel HA, Patel JD. History and systematic review of wear and osteolysis outcomes for first-generation highly crosslinked polyethylene. *Clin Orthop*. 2011;469(8):2262-2277. doi:10.1007/s11999-011-1872-4
18. Glyn-Jones S, Thomas GER, Garfjeld-Roberts P, *et al.* The John Charnley Award: Highly crosslinked polyethylene in total hip arthroplasty decreases long-term wear: a double-blind randomized trial. *Clin Orthop*. 2015;473(2):432-438. doi:10.1007/s11999-014-3735-2

19. Paxton EW, Inacio MCS, Namba RS, *et al.* Metal-on-conventional polyethylene total hip arthroplasty bearing surfaces have a higher risk of revision than metal-on-highly crosslinked polyethylene: results from a US registry. *Clin Orthop.* 2015;473(3):1011-1021. doi:10.1007/s11999-014-4105-9
20. Paxton E, Cafri G, Havelin L, *et al.* Risk of Revision Following Total Hip Arthroplasty: Metal-on-Conventional Polyethylene Compared with Metal-on-Highly Cross-Linked Polyethylene Bearing Surfaces: International Results from Six Registries. *J Bone Joint Surg Am.* 2014;96(Suppl 1):19-24. doi:10.2106/JBJS.N.00460
21. Hanna SA, Somerville L, McCalden RW, *et al.* Highly cross-linked polyethylene decreases the rate of revision of total hip arthroplasty compared with conventional polyethylene at 13 years' follow-up. *Bone Jt J.* 2016;98-B(1):28-32. doi:10.1302/0301-620X.98B1.36527
22. Hara D, Nakashima Y, Yamamoto T, *et al.* Late failure of annealed highly cross-linked polyethylene acetabular liner. *J Mech Behav Biomed Mater.* 2013;28:206-212. doi:10.1016/j.jmbbm.2013.08.003
23. Tower SS. Rim Cracking of the Cross-Linked Longevity Polyethylene Acetabular Liner After Total Hip Arthroplasty. *J Bone Joint Surg Am.* 2007;89(10):2212. doi:10.2106/JBJS.F.00758
24. Moore KD, Beck PR, Petersen DW, *et al.* Early Failure of a Cross-Linked Polyethylene Acetabular Liner: A Case Report. *J Bone Joint Surg Am.* 2008;90(11):2499-2504. doi:10.2106/JBJS.G.01304
25. Waewsawangwong W, Goodman SB. Unexpected Failure of Highly Cross-Linked Polyethylene Acetabular Liner. *J Arthroplasty.* 2012;27(2):323.e1-323.e4. doi:10.1016/j.arth.2011.04.010
26. Ast MP, John TK, Labbisiere A, *et al.* Fractures of a single design of highly cross-linked polyethylene acetabular liners: an analysis of voluntary reports to the United States Food and Drug Administration. *J Arthroplasty.* 2014;29(6):1231-1235. doi:10.1016/j.arth.2013.12.022
27. Duffy GP, Wannomae KK, Rowell SL, *et al.* Fracture of a Cross-Linked Polyethylene Liner Due to Impingement. *J Arthroplasty.* 2009;24(1):158.e15-158.e19. doi:10.1016/j.arth.2007.12.020
28. Furmanski J, Anderson M, Bal S, *et al.* Clinical fracture of cross-linked UHMWPE acetabular liners. *Biomaterials.* 2009;30(29):5572-5582. doi:10.1016/j.biomaterials.2009.07.013
29. Blumenfeld TJ, McKellop HA, Schmalzried TP, *et al.* Fracture of a Cross-Linked Polyethylene Liner. *J Arthroplasty.* 2011;26(4):666.e5-666.e8. doi:10.1016/j.arth.2010.07.009

30. MacDonald D, Sakona A, Ianuzzi A, *et al.* Do First-generation Highly Crosslinked Polyethylenes Oxidize *In vivo*? *Clin Orthop Relat Res.* 2011;469(8):2278-2285. doi:10.1007/s11999-010-1728-3
31. Wannomae KK, Bhattacharyya S, Freiberg A, *et al.* *In vivo* oxidation of retrieved cross-linked ultra-high-molecular-weight polyethylene acetabular components with residual free radicals. *J Arthroplasty.* 2006;21(7):1005-1011. doi:10.1016/j.arth.2005.07.019
32. Currier BH. Evaluation of Oxidation and Fatigue Damage of Retrieved Crossfire Polyethylene Acetabular Cups. *J Bone Joint Surg Am.* 2007;89(9):2023. doi:10.2106/JBJS.F.00336
33. Kurtz SM, Hozack W, Turner J, *et al.* Mechanical Properties of Retrieved Highly Cross-Linked Crossfire Liners After Short-Term Implantation. *J Arthroplasty.* 2005;20(7):840-849. doi:10.1016/j.arth.2005.07.015
34. Kurtz SM, Austin MS, Azzam K, *et al.* Mechanical Properties, Oxidation, and Clinical Performance of Retrieved Highly Cross-Linked Crossfire Liners After Intermediate-Term Implantation. *J Arthroplasty.* 2010;25(4):614-623.e2. doi:10.1016/j.arth.2009.04.022
35. Kurtz SM, Hozack WJ, Purtill JJ, *et al.* 2006 Otto Aufranc Award Paper: Significance of *In vivo* Degradation for Polyethylene in Total Hip Arthroplasty: *Clin Orthop.* 2006;453:47-57. doi:10.1097/01.blo.0000246547.18187.0b
36. Currier BH, Van Citters DW, Currier JH, *et al.* *In vivo* Oxidation in Remelted Highly Cross-Linked Retrievals: *J Bone Joint Surg Am.* 2010;92(14):2409-2418. doi:10.2106/JBJS.I.01006
37. Miura Y, Hasegawa M, Sudo A, *et al.* In-vivo degradation of middle-term highly cross-linked and remelted polyethylene cups: Modification induced by creep, wear and oxidation. *J Mech Behav Biomed Mater.* 2015;51:13-24. doi:10.1016/j.jmbbm.2015.06.028
38. Muratoglu OK, Wannomae KK, Rowell SL, Micheli BR, Malchau H. *Ex vivo* stability loss of irradiated and melted ultra-high molecular weight polyethylene. *J Bone Joint Surg Am.* 2010;92(17):2809-2816. doi:10.2106/JBJS.I.01017
39. Rowell SL, Reyes CR, Malchau H, *et al.* *In vivo* Oxidative Stability Changes of Highly Cross-Linked Polyethylene Bearings: An *Ex vivo* Investigation. *J Arthroplasty.* 2015;30(10):1828-1834. doi:10.1016/j.arth.2015.05.006
40. Wernlé JD, Gilbert JL. Micromechanics of shelf-aged and retrieved UHMWPE tibial inserts: indentation testing, oxidative profiling, and thickness effects. *J Biomed Mater Res B Appl Biomater.* 2005;75(1):113-121. doi:10.1002/jbm.b.30285

41. Gilbert JL, Merkhan I. Rate effects on the microindentation-based mechanical properties of oxidized, crosslinked, and highly crystalline ultrahigh-molecular-weight polyethylene. *J Biomed Mater Res A*. 2004;71(3):549-558. doi:10.1002/jbm.a.30196
42. Collier JP, Currier BH, Kennedy FE, *et al*. Comparison of cross-linked polyethylene materials for orthopaedic applications. *Clin Orthop*. 2003;(414):289-304. doi:10.1097/01.blo.0000073343.50837.03
43. Kurtz SM, MacDonald DW, Mont MA, *et al*. Retrieval analysis of sequentially annealed highly crosslinked polyethylene used in total hip arthroplasty. *Clin Orthop*. 2015;473(3):962-971. doi:10.1007/s11999-014-4113-9
44. Kurtz SM, Oral E. 27 - *In vivo* Oxidation of UHMWPE. In: *UHMWPE Biomaterials Handbook (Third Edition)*. Oxford: William Andrew Publishing; 2016:488-505. doi:10.1016/B978-0-323-35401-1.00027-2
45. Oral E, Ghali BW, Neils A, *et al*. A new mechanism of oxidation in ultrahigh molecular weight polyethylene caused by squalene absorption. *J Biomed Mater Res B Appl Biomater*. 2012;100(3):742-751. doi:10.1002/jbm.b.32507
46. Fung M, Bowsher JG, Van Citters DW. Variation of mechanical properties and oxidation with radiation dose and source in highly crosslinked remelted UHMWPE. *J Mech Behav Biomed Mater*. 2018;82:112-119. doi:10.1016/j.jmbbm.2018.03.005
47. Singh G. Mechanical Properties of Retrieved Highly Cross-linked Polyethylene Acetabular Liners in Total Hip Arthroplasty. 2017. <https://ir.lib.uwo.ca/etd/4667>

Chapter 6

6 Effects of Free Radical Stabilization on Changes in Mechanical and Structural Properties of Retrieved Highly Cross-Linked Polyethylene Acetabular Liners

6.1 Introduction

UHMWPE used in biomedical polyethylene bearings is a semi-crystalline material composed primarily of both a well-organized, densely packed lamellar crystalline phase and a disorganized amorphous phase (1). The success of this material has been limited by long-term *in vivo* wear and associated complications (2-4), leading to the development of a more wear resistant highly cross-linked polyethylene (HXLPE). To create cross-linking in UHMWPE, gamma or electron beam irradiation is used to create polyethylene chain bond cleavages and free radicals which, in an inert environment, can recombine to form cross-links within the polyethylene chains. However, due to the limited chain mobility within the crystalline regions of polyethylene, free radicals in this region can become trapped (5) and react with oxygen to form alkyl free radicals, leading to a self-perpetuating oxidation process that leads to significant material degradation and changes in implant properties (6-8).

Free radical stabilization processes were introduced to HXLPE production in order to avoid free radical-induced material degradation. First generation HXLPE implants underwent thermal stabilization through either post-irradiation remelting or annealing. Remelting polyethylene allows the rigid crystalline regions to mobilize and free radicals present in these regions to be neutralized by cross-linking, leaving undetectable levels of free radicals (9). However, cross-linking reduces chain mobility, and as such the ability to reform crystalline regions within the polyethylene is compromised and overall crystallinity of the implant is reduced. This ultimately leads to a decrease in ultimate strength, yield strength, and fatigue resistance (6,10). Alternatively, annealing does not completely melt the crystalline phase leaving some residual free radicals. However, this allows the crystallinity of annealed HXLPE to remain relatively unchanged from the pretreatment state, and as such the mechanical properties are preserved (11,12). A second

generation of HXLPE implants has utilized a sequential annealing process to further reduce the amount of residual free radicals while maintaining mechanical properties (13). Clinical and *in vitro* studies have found a significant reduction in wear rates, osteolysis and wear-related revision surgery rates for all HXLPE compared to conventional UHMWPE, despite their inherent differences (14-20).

Although wear properties are significantly improved in HXLPE compared to conventional UHMWPE, there have been a number of reports of mechanical failure of HXLPE acetabular liners, particularly at the implant rim (21-28). To this point these failures have largely been considered multifactorial. A number of retrieval studies have found evidence of *in vivo* oxidation of first and second generation annealed HXLPE acetabular liners, in particular at the implant rim (29-34). Furthermore, *In vivo* oxidation of remelted polyethylene has been detected at both the articular surface and the implant rim despite undetectable free radical concentrations (29,35-38). Even with evidence of *in vivo* oxidation in all forms of first-generation polyethylene and cases of *in vivo* mechanical failure at the implant rim, the mechanical properties of the implant rim after *in vivo* use is not well described in the literature. The mechanical properties of retrieved HXLPE liner rims have been previously assessed, identifying an increase in the hardness in remelted liner rims after extended *in vivo* exposure, with no evidence of changes in hardness for single or sequentially annealed liner rims. Increased hardness in polyethylene has been associated with oxidation (39,40), and oxidation is known to increase the relative amount of crystalline phase within polyethylene and increase the risk of fatigue failure (7,41). The purpose of the current study is to examine if there is evidence of oxidation or microstructural changes in retrieved HXLPE liner rims after extended *in vivo* time that could be associated with the mechanical property differences found in the mechanical testing study previously performed. It is hypothesized that liners with increased rim hardness after *in vivo* use will demonstrate evidence of detectable oxidation and a subsequent increase in the crystalline phase in the rim.

6.2 Materials and Methods

6.2.1 Implant Selection

A review of the implant retrieval lab (IRL) database was performed to obtain a list of available HXLPE acetabular liners with *ex vivo* times less than one year to reduce to potential impact of shelf oxidation on testing results. In addition, liners were obtained from an outside institution which met the inclusion criteria for testing. Institutional review board approval was obtained for access to the retrieved implants and associated patient data. All retrieved implants from the IRL underwent an identical sanitation and storage protocol including cleansing in a 10% bleach solution, fixation in 10% formalin solution, and storage wrapped in gauze in a closed cardboard box stored in a clean, dry and well-ventilated storage room at ambient temperature in room air. Outside institution implants were processed and frozen within 30 days of extraction. Implants were placed in 10% formalin solution for 2-14 days, rinsed in water for 30 minutes, hand scrubbed with mild soap, dried and stored in a -86°C freezer to prevent further oxidation. These samples were considered to have no *ex vivo* time given the rapid storage in a dormant state. Both groups of samples had similar cleansing and fixation techniques and both techniques of storage are considered acceptable for property assessment (29,32,33). Inclusion criteria included implants with *ex vivo* time of one year or less, implants having undergone thermal free radical stabilization during manufacturing, ability to identify the specific HXLPE material of the implant, and an implant rim without significant damage from removal with a suitable testing rim surface for testing. Exclusion criteria included *ex vivo* time over one year, conventional UHMWPE, implants lacking appropriate identifiers to confirm the material, and implant rims with significant damage from removal and/or lacking a suitable rim surface for testing. A total of 16 retrieved implants were identified that met inclusion criteria (table 6-1). Patient gender, age, indication for revision, *in vivo* time and *ex vivo* time for each implant is provided in appendix B. One control liner for each type of HXLPE tested in the retrieval cohort was also assessed to observe any changes after *in vivo* time compared to baseline properties, for a total of five controls.

Table 6-1 - Summary of retrieval and control implant data

<i>Manufacturer</i>	<i>Depuy</i>	<i>Zimmer</i>	<i>Smith & Nephew</i>	<i>Stryker</i>	<i>Stryker</i>
<i>HXLPE Material</i>	AltrX	Longevity	XLPE	X3	X3
<i>N (retrievals)</i>	2	3	3	4	4
<i>N (controls)</i>	1	1	1	1	1
<i>Stabilization Method</i>	Remelted	Remelted	Remelted	Single Annealed	Sequentially Annealed
<i>Stock Material</i>	GUR1020	GUR1050	GUR1050	GUR1050	GUR1020
<i>Radiation Dose (kGy)</i>	75	100	100	90	105*

*75 kGy cross-linking dose with 30 kGy for sterilization after thermal treatment

6.2.2 Microindentation Testing

Microindentation hardness testing was performed along the rim surface of each acetabular liner according to ASTM E384 using a Micromet II Vickers microhardness tester (Buehler Ltd, Lake Bluff, IL). Testing was focused along the rim region only to do the requirements of a flat surface for testing accuracy and the specific interest in rim mechanical properties. Testing was performed in an independent laboratory in a blind fashion by a single operator under identical testing conditions. Calibration was performed using a standard steel carbon sample with a known Vickers hardness number (HV) of 335-350 kgf/mm². Each liner was mounted into the tester fixed in a plaster mold. A square-based diamond indenter was used to apply a load of 0.0254 kgf into the flat surface of the rim for a 10 second dwell time. The diagonal lengths (d_1 , d_2) of the resultant indentation were measured using the micro-ruler on the machine's microscope, measured at 40x magnification (figure 6-1). Each rim was tested with 10 to 16 indentations. The HV for each sample was calculated using the following equation:

$$HV = 1.8544 \frac{F}{d^2}$$

Where d is the mean diagonal length of the indentation in mm ($d=(d_1+d_2)/2$). A mean HV and standard deviation was calculated for each sample.

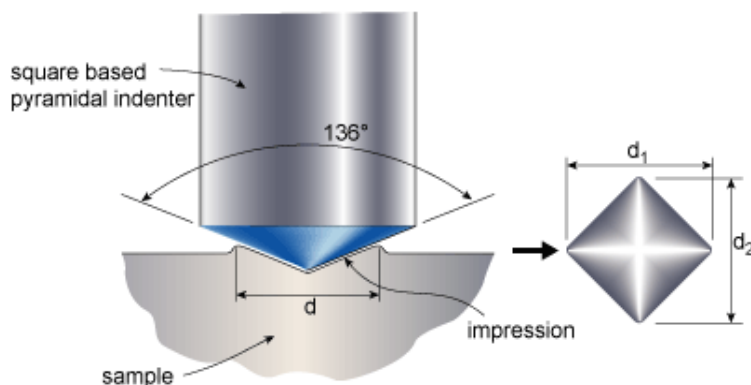

Figure 6-1 - Vickers Microindentation with a square-based diamond tip indenter. The Indenter is loaded into the implant rim surface with a predefined loading force and dwell time, leaving a residual surface indentation. The resultant diagonal lengths (d_1 and d_2) can be measured under an optical microscope. (Courtesy TWI Ltd. Hardness Testing Part 1 - Job Knowledge 74, <https://www.twi-global.com/technical-knowledge/job-knowledge/hardness-testing-part-1-074> (accessed 24 June, 2018))

6.2.3 Sample Preparation and Fourier Transform Infrared Spectroscopy Analysis

Using a jeweler's saw, each liner had a section removed that included the implant rim through the center of the articular surface to expose a vertical cross section of the implant (figure 6-2). The saw was kept at low speed and generated minimal heat and friction during sample preparation. Thin slices (~200 microns thick) were removed parallel to the cross-sectioned surface, extending from the bearing side to the backside of the implant at both the central portion of the articular surface and the rim regions. Each slice was then boiled in hexane at a temperature of 69°C for six hours to extract absorbed esterified fatty acids, and subsequently air dried.

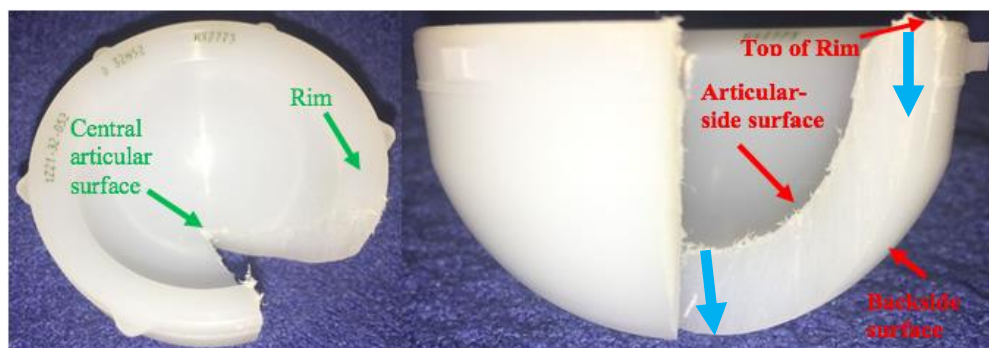

Figure 6-2 – Representative implant with removed cross section and indication of locations assessed. Note that the blue arrows indicate the location and direction of the FTIR scans performed both at the articular surface and the rim of the removed cross sections.

The vertical sections from each region of the implant were then assessed for oxidation using a Bruker Hyperion 2000 Fourier transform infrared (FTIR) microscope (Bruker Daltonics Inc, Billerica, MA) attached to a Tensor II spectrometer. Oxidation index (OI) values were calculated according to ASTM F2102 by integrating the area of the peaks arising from the carbonyl groups from 1680 to 1775 cm^{-1} and ratioing that area to the area of the peak arising from the polyethylene, at approximately 1368 cm^{-1} . In order to understand oxidation as a function of depth, line scans were collected using a $200\text{ }\mu\text{m}$ square window at $200\text{ }\mu\text{m}$ intervals from the bearing side to the backside of the implant at the central articular surface and from the top down 3 mm into the bulk at the rim.

6.2.4 Raman Spectroscopy Analysis

Raman spectroscopy was used to assess for changes in the crystalline phase fraction of polyethylene as it relates to oxidative changes. A Renishaw InVia Raman spectrometer (Renishaw Plc, Gloucestershire, UK) equipped with a 514 nm laser, delivering approximately 8 mW of power at the surface of the sample, was used in confocal mode for the analysis. The cross section of the rim section was mapped near the top surface, at the depth of maximum oxidation as detected with FTIR, and in the bulk of the material using a $20\times$ objective. If no detectable oxidation (oxidation index < 0.1) was noted by FTIR, the sample was mapped 1 mm from the top surface. The mapping was carried out

in a 50 μm by 50 μm area, collecting 121 data points. The data points from the map were averaged and the averaged spectrum was baseline corrected. After restricting the peak position and full width at half maximum to reasonable ranges, a spectral deconvolution was performed using an automatic curve fitting routine in the Renishaw Wire 4.1 software package. Using previously described calculation methods for determining the phase fraction of polyethylene, the fraction of the amorphous (α_a), crystalline (α_c), and intermediate (α_i) phases of UHMWPE is determined based on the following equations (42):

$$\alpha_c = \frac{I_{1414}}{0.46(I_{1293} + I_{1305})}$$

$$\alpha_a = \frac{I_{1305}}{I_{1293} + I_{1305}}$$

$$\alpha_i = 1 - (\alpha_c + \alpha_a)$$

Where I is the integrated area of each individual Raman band. The 1414 cm^{-1} band represents the orthorhombic crystalline phase, the 1305 cm^{-1} band represents the amorphous phase, and the combination of the 1293 cm^{-1} and 1305 cm^{-1} bands represent an internal intensity standard (43,44).

6.2.5 Scanning Electron Microscopy

All 16 retrieved rim samples were examined by scanning electron microscopy (SEM) using a Hitachi SU3500 Variable Pressure SEM (Hitachi Ltd, Tokyo, Japan). The samples were given a light coating of gold to alleviate charging. The images were collected using an accelerating voltage of 15 keV at two magnifications, 500X and 1000X. Each sample surface was examined for the presence of possible microcracks. If microcracks were found, they were imaged. Representative areas on the rim surface of the inner diameter (near the articular surface), middle and outer diameter of the rim of each sample were imaged.

6.2.6 Statistical Analysis

Statistical analysis was performed using SPSS (Version 25, IBM Corp., Armonk, NY). Spearman's rank-order correlations were performed to assess for relationships between variables where appropriate. Mann-Whitney U and Kruskal-Wallis H test were used to assess for differences in means, where appropriate.

6.3 Results

Average age at the time of revision was 69.1 years and 68.8% of patients were male. Indication for revision surgery were infection (31.3%), periprosthetic fracture (18.8%), recalcitrant pain (18.8%), aseptic loosening (6.2%), instability (6.2%), revision of a recalled implant (6.2%), implant malposition (6.2%), and trunnionosis (6.2%). *In vivo* and *ex vivo* times for each thermal stabilization group are presented in table 6-2. There was no statistically significant difference between groups for *in vivo* time ($p=.295$) and *ex vivo* time ($p=.539$).

Table 6-2 - *In vivo* and *ex vivo* times (years) for each thermal stabilization group

<i>Thermal Stabilization</i>	<i>Remelted</i> (<i>n</i> =8)	<i>Single</i> <i>Annealed</i> (<i>n</i> =4)	<i>Sequentially</i> <i>Annealed</i> (<i>n</i> =4)
<i>In vivo Time, Mean</i>	8.63	11.22	7.09
<i>In vivo Time, Range</i>	5.88 – 13.74	5.40 - 14.01	5.63 – 9.45
<i>Ex vivo Time, Mean</i>	0.45	0.57	0.57
<i>Ex vivo Time, Range</i>	0 – 0.73	0.33 – 1.00	0 – 0.84

Rim oxidation as a product of depth in retrieved THA liners with detectable oxidation ($OI>0.1$) is presented in figures 6-3 through 6-5. Average maximum rim oxidation for retrieved and control liners is presented in table 6-3. Rim oxidation occurred in the subsurface region when present. Representative optical images of liners with evidence of oxidation from each thermal stabilization group is provided in figure 6-6, demonstrating characteristic white bands in the subsurface region of the oxidized rim.

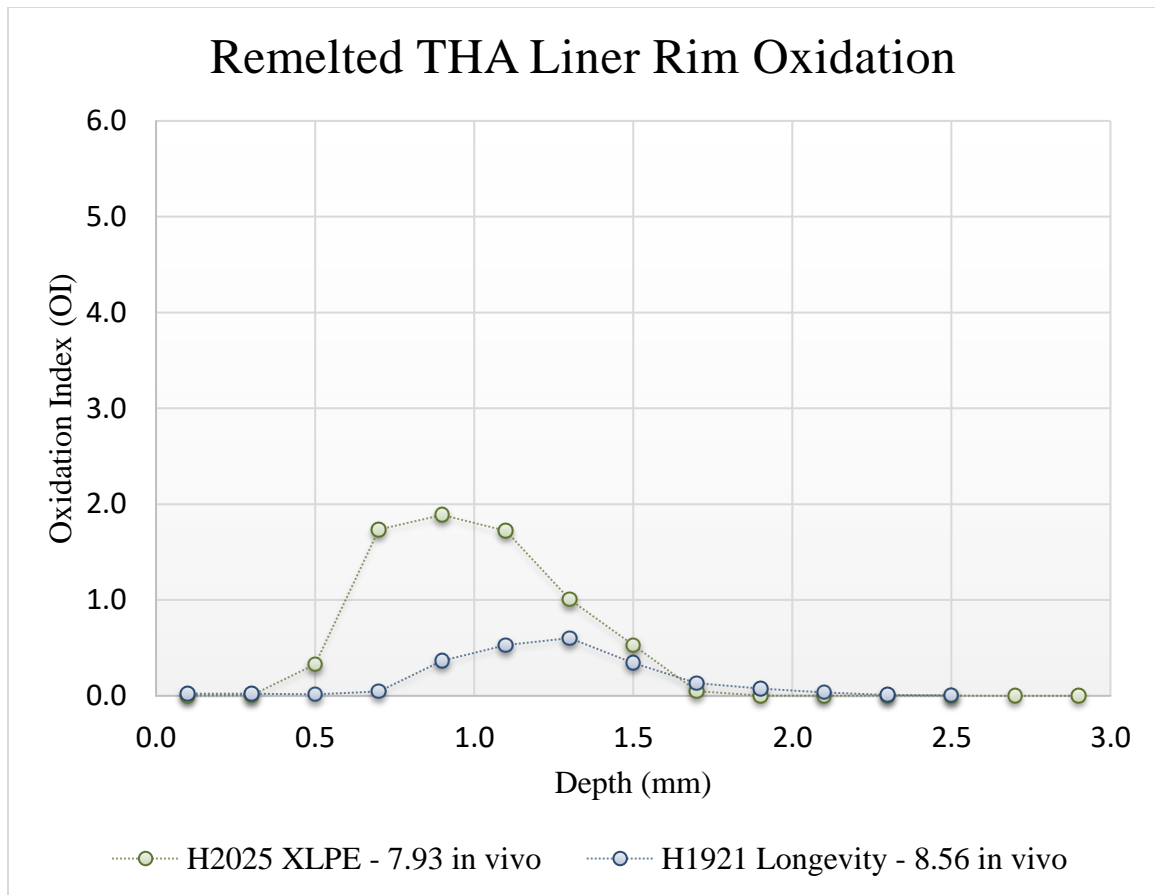

Figure 6-3 - Oxidation Indices of remelted liner rims with detectable oxidation. Note that all remelted control liners and remaining remelted retrieved liners demonstrated $OI < 0.1$ throughout the rim

Remelted liners demonstrated the lowest overall maximum rim oxidation, followed by sequentially annealed and single annealed liners, respectively. Of the remelted liners, 25% (2/8) liners demonstrated a detectable level of rim oxidation ($OI > 0.1$), with one liner with *in vivo* time of 7.93 years demonstrating significant oxidation ($OI_{max} = 1.89$). The control remelted liners did not demonstrate detectable rim oxidation. There was no correlation between maximum rim oxidation and *in vivo* time.

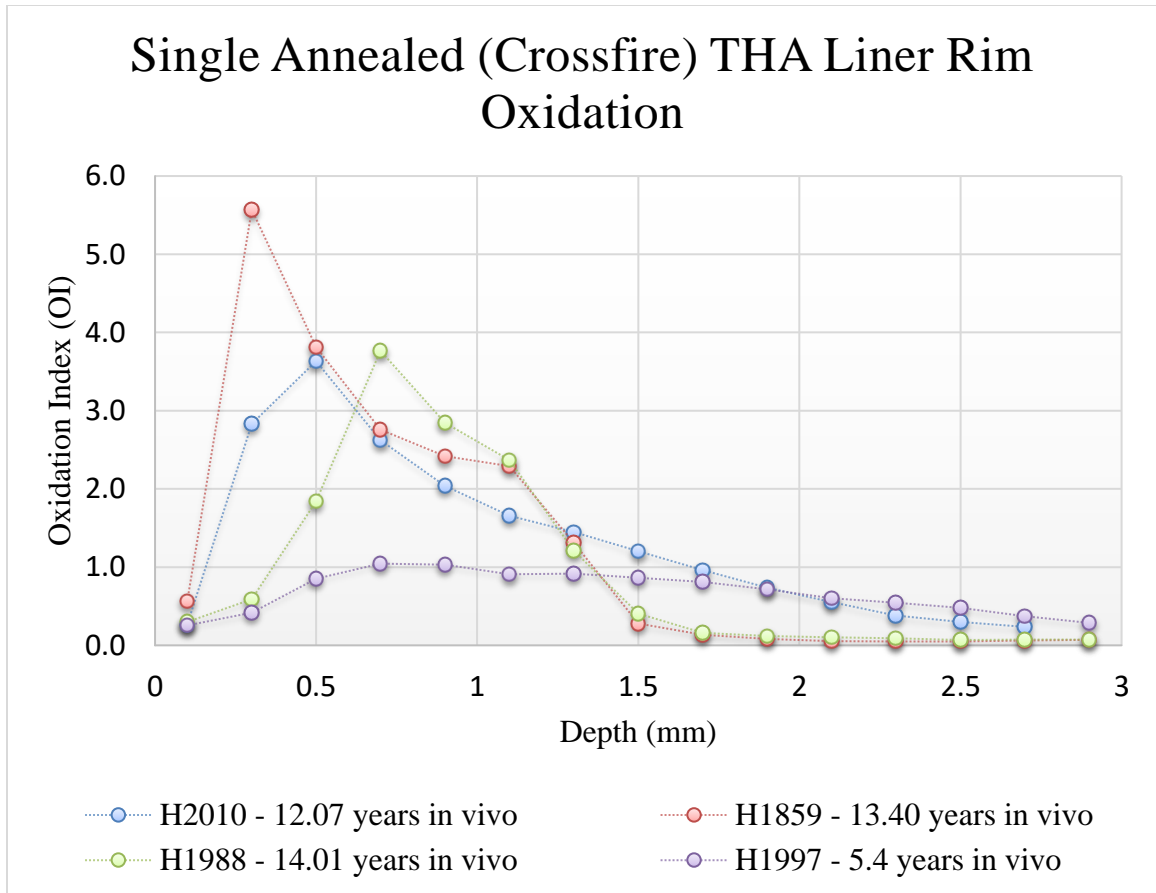

Figure 6-4 - Oxidation Indices of single annealed retrieved and control liner rims. All samples, including the control liner, had a rim OI > 0.1

All retrieved single annealed liners (4/4) demonstrated significant rim oxidation ($OI_{\max} > 1$), with oxidation levels ranging from 1.04 – 5.07. The control single annealed liner demonstrated detectable but low rim oxidation ($OI_{\max} = 0.2$). There was a positive correlation between maximum rim oxidation and *in vivo* time ($\rho = .90, p = .037$).

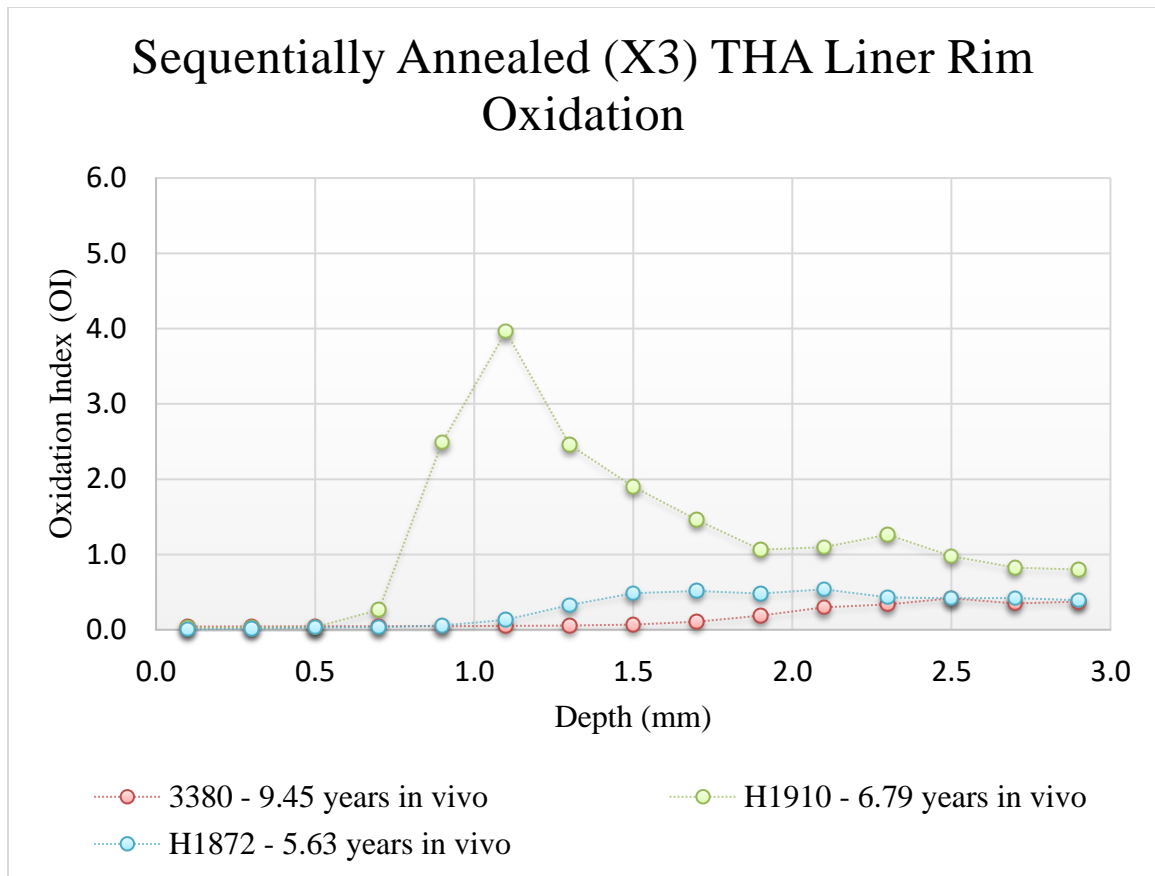

Figure 6-5 - Oxidation Indices of sequentially annealed liner rims with detectable oxidation. The control liner demonstrated low but detectable oxidation

Seventy-five percent (3/4) of retrieved sequentially annealed liners demonstrated detectable levels of rim oxidation, with one liner with *in vivo* time of 6.79 years demonstrating significant oxidation ($OI_{max} = 3.96$). All liners with evidence of oxidation also had oxidation beyond the subsurface region into the implant bulk. The control sequentially annealed liner demonstrated detectable but low rim oxidation ($OI_{max} = 0.10$). There was no correlation between maximum rim oxidation and *in vivo* time.

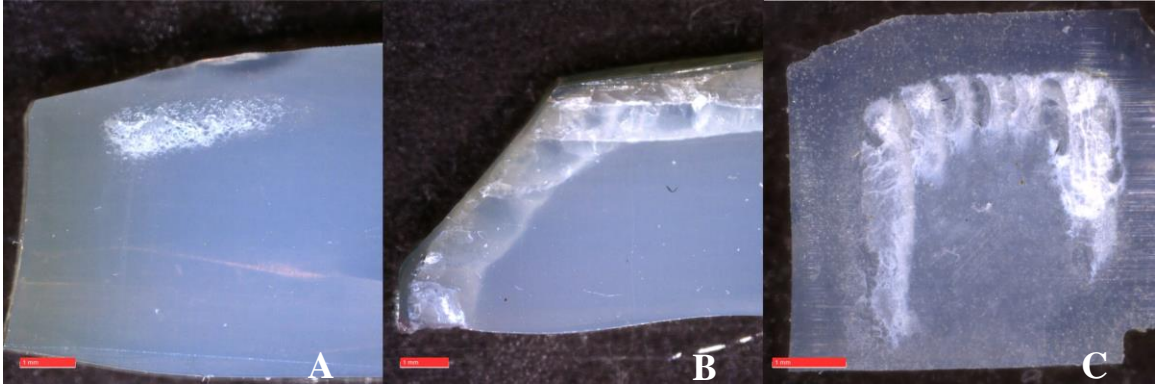

Figure 6-6 - Representative optical images of oxidized liner rim cross sections. (A) Remelted liner rim with $OI_{max}=1.89$ and *in vivo* time of 7.93 years. (B) Single annealed liner rim with $OI_{max}=5.57$ and *in vivo* time of 13.4 years. (C) Sequentially annealed liner rim with $OI_{max}=3.96$ and *in vivo* time of 6.79 years

Detectable oxidation was found at the articular surface in 62.5% (5/8) of remelted liners, with no liners exhibiting an $OI_{max} > 1$. All (8/8) single and sequentially annealed retrieved liners demonstrated detectable articular surface oxidation. None of the sequentially annealed liners exhibited an $OI_{max} > 1$. One single annealed liner with an *in vivo* time of 13.4 years demonstrated significant articular surface oxidation ($OI_{max}=2.65$). Oxidation was evident in the subsurface region, when present.

Table 6-3 - Vickers Hardness, oxidation, and crystalline phase percentage data from retrieved and control liner rims for each thermal stabilization group

Remelted	<i>Retrievals (n=8)</i>	<i>Controls (n=3)</i>
<i>Vickers Hardness, Rim (kgf/mm²)</i>	3.87	3.64
<i>Average Rim Oxidation Index</i>	0.32	0.01
<i>Average Articular Surface Oxidation Index</i>	0.19	0.02
<i>Average Rim Crystalline Phase (%), at surface</i>	35.7%	34.4%
<i>Average Rim Crystalline Phase (%), at OI_{max}</i>	36.6%	38.6%
<i>Average Rim Crystalline Phase (%), at bulk</i>	36.9%	38.2%
Single Annealed	<i>Retrievals (n=4)</i>	<i>Controls (n=1)</i>
<i>Vickers Hardness, Rim (kgf/mm²)</i>	4.72	4.46
<i>Average Rim Oxidation Index</i>	3.50	0.19
<i>Average Articular Surface Oxidation Index</i>	1.00	0.21
<i>Average Rim Crystalline Phase (%), at surface</i>	46.7%	41.6%
<i>Average Rim Crystalline Phase (%), at OI_{max}</i>	57.2%	45.0%
<i>Average Rim Crystalline Phase (%), at bulk</i>	44.1%	41.7%
Sequentially Annealed	<i>Retrievals (n=4)</i>	<i>Controls (n=1)</i>
<i>Vickers Hardness, Rim (kgf/mm²)</i>	4.65	4.33
<i>Average Rim Oxidation Index</i>	1.24	0.10
<i>Average Articular Surface Oxidation Index</i>	0.30	0.09
<i>Average Rim Crystalline Phase (%), at surface</i>	35.0%	40.4%
<i>Average Rim Crystalline Phase (%), at OI_{max}</i>	53.9%	42.4%
<i>Average Rim Crystalline Phase (%), at bulk</i>	48.3%	43.3%

***control sample crystalline phase % measured at surface, 1 mm, and 3 mm depths**

The average orthorhombic crystallinity for retrieved and control liners at the rim surface, region of maximum oxidation, and bulk is presented in table 6-3. Remelted liner rims were generally composed of a lower percentage of crystalline phase than single or sequentially annealed liner rims. Retrieved remelted liners demonstrated little difference in the percentage of crystalline phase at the region of maximum oxidation when compared to the material bulk (~3 mm deep), which was unaffected by oxidation, as well as compared to the control liners. Table 6-4 compares the Vickers hardness, average rim oxidation and crystalline phase percentage of retrieved remelted liners with detectable and undetectable levels of rim oxidation. The crystalline phase percentage and hardness were not appreciably different in the oxidized group when compared to the unoxidized

group. There was no correlation between hardness and oxidation ($p=.346$) or hardness and crystallinity at the subsurface ($p=.947$), or bulk ($p=.573$) of the implant.

Table 6-4 - Vickers Hardness, oxidation, and crystalline phase percentage data from remelted retrieved and control liner rims based for samples with and without detectible levels of oxidation

<i>Retrieved Remelted Liners</i>	$OI_{max} > 0.1$ (n=2)	$OI_{max} < 0.1$ (n=6)
<i>Vickers Hardness, Rim (kgf/mm²)</i>	3.89	3.86
<i>Average Rim Oxidation Index</i>	1.25	0.02
<i>Average Rim Crystalline Phase (%), at surface</i>	34.5%	36.2%
<i>Average Rim Crystalline Phase (%), at OI_{max}</i>	35.2%	37.0%
<i>Average Rim Crystalline Phase (%), at bulk</i>	34.9%	37.6%

In the single annealed retrieved liners, the average crystalline phase percentage in the region of maximum oxidation was over 12% higher than the bulk of the rim as well as all regions of the control liner. The average Vickers hardness was 5.8% higher in these samples compared to the control liner. There was no correlation between hardness and oxidation ($p=.747$) or hardness and crystallinity at the subsurface ($p=.391$), or bulk ($p=.104$) of the implant.

In sequentially annealed liners, the average crystallinity in the region of maximum oxidation was approximately 5% higher than the material bulk and 10% higher than all regions of the control implant. The average hardness was 7.4% higher in the retrieved liners than the control liner. There was no correlation between hardness and oxidation ($p=.285$), but there was a positive correlation between hardness and crystallinity at the subsurface ($\rho=.90$, $p=.037$) and bulk ($\rho=.90$, $p=.037$) of the implant. One liner (25%) demonstrated $OI_{max}>1$ at the rim, with 3/4 (75%) having rim $OI_{max}<1$. The single liner rim with significant oxidation ($OI_{max}=3.96$) demonstrated a 17.9% higher crystallinity in region of maximum oxidation compared to the deeper material bulk and 24.9% and 24% higher than the control liner subsurface and bulk regions, respectively. Liner rims with an $OI_{max}<1$ had nearly identical average crystallinity in the subsurface and bulk, with only 7% and 4.7% higher crystallinity compared to the control liner in these regions (table 6-5).

Table 6-5 - Vickers Hardness, oxidation, and crystalline phase percentage data from sequentially annealed retrieved and control liner rims based on extent of oxidation

<i>Retrieved Sequentially Annealed</i>	$OI_{max} > 1$ (n=1)	$OI_{max} < 1$ (n=3)	<i>Control</i>
<i>Vickers Hardness, Rim (kgf/mm²)</i>	4.75	4.62	4.33
<i>Average Rim Oxidation Index</i>	3.96	0.33	0.10
<i>Average Rim Crystalline Phase (%), at surface</i>	27.1%	37.7%	40.4%
<i>Average Rim Crystalline Phase (%), at OI_{max}</i>	67.3%	49.4%	42.4%
<i>Average Rim Crystalline Phase (%), at bulk</i>	49.4%	48.0%	43.3%

Scanning electron microscopy images of liner rims demonstrated significant variability in surface topography. Only one samples, a remelted liner, demonstrated signs of microcracking in the central portion of the rim surface (figure 6-7). No single or sequentially annealed liners demonstrated evidence of microcracking on SEM.

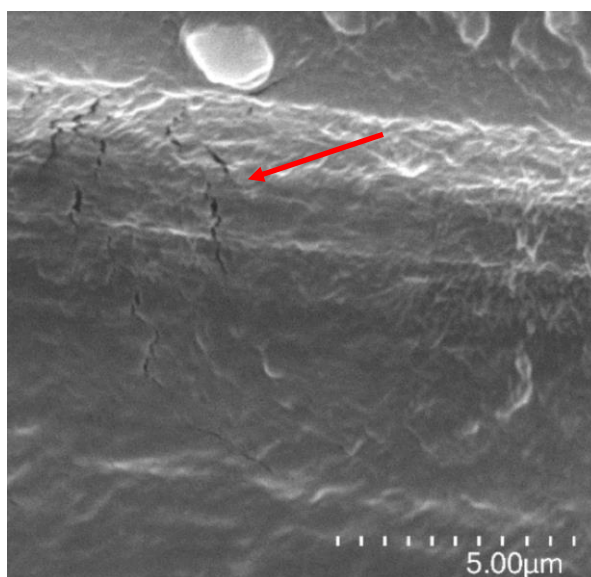

Figure 6-7 - SEM image of a sample demonstrating evidence of surface microcracking along the rim in a remelted liner with no detectable oxidation in the middle of the rim

6.4 Discussion

Understanding the behavior of HXLPE acetabular liners after long-term implantation is important to predict long-term clinical performance. The bearing surface of HXLPE has been the focal point of most retrieval studies, however the implant rim is an area of

particular interest given the numerous reports of HXLPE liner failures at the implant rim (21-28). Oxidative changes have been identified in previously in single annealed, sequentially annealed, and remelted HXLPE acetabular liners. However, associated changes in mechanical and microstructural properties have not been well characterized.

Rim oxidation was markedly higher and more frequent in retrieved single annealed liners compared to other thermal free radical stabilization techniques. Oxidation in this group was correlated with *in vivo* time. A number of prior studies have confirmed the relative lack of oxidative stability at the rim of single annealed HXLPE liners after *in vivo* use (29,31-34). The liner rims in this cohort generally demonstrated a higher crystallinity in the subsurface region, where oxidation was highest, compared to the crystallinity in the unoxidized region of the rim as well as the control implant rim. It has previously been shown that single annealed liners with evidence of articular oxidation demonstrated increased crystallinity, especially when $OI_{max} > 1$ (30). The results from this study obtained along the implant rim demonstrate a similar trend, with the average crystallinity of retrievals in the region of maximal oxidation being 12.1% and 15.5% higher than the control liner subsurface and bulk regions, respectively. Sequentially annealed liner rims demonstrated a relatively high frequency of detectable oxidation, though average oxidation was lower than single annealed liners and only one liner demonstrated significant oxidation with an $OI_{max} > 1$. This is consistent with prior retrieval analysis with evidence of rim oxidation in both sequentially and single annealed liners, with markedly higher average oxidation in the single annealed liner rims (45,46). The average crystallinity in the region of maximum oxidation was only 5.6% higher than the bulk of the rim, but 11.5% higher than the subsurface region of the control liner. This is likely due to the presence of oxidation in the deeper portions of the retrieved liners, leading to an increase in crystallinity in this area. When $OI_{max} > 1$ there was a sharp increase in crystallinity in the region of maximum oxidation compared to the control liner and the liners with $OI_{max} < 1$. The changes in the crystallinity seen in both single and sequentially annealed liners is most likely secondary to oxidation from the presence of residual free radicals, with the higher oxidation seen in the single annealed liners due to higher levels of residual free radicals after cross-linking. Both single and sequentially annealed liner rims in this study demonstrated elevated hardness compared to their respective control

liners, more so than demonstrated in the previous mechanical testing study. This may be due to selection bias towards samples with longer *in vivo* times in this study, as well as the much more limited number of samples and controls. A relationship between oxidation and decreased mechanical properties of retrieved single annealed acetabular liners along the articular surface has previously been established (29,34), however sequentially annealed retrieved liners have not shown a similar decrease despite low but detectable oxidation in the same region (45). It should be noted that the method of mechanical testing performed in these studies assessed ultimate load through small punch testing whereas this study tested indentation hardness. Though a general relationship between tensile and hardness properties has been described, it can vary based on different material properties (47), limiting direct comparison between these results and small punch test results from these other studies. Despite detectable and sometimes significant oxidation, the hardness increase for both groups in this study was less than 7.5% compared to controls and no liners were revised for mechanical failure.

Remelted liners demonstrated the lowest frequency of rim oxidation, however two samples were identified with evidence of rim oxidation, with one sample having significant oxidation. Oxidation of remelted HXLPE liners has been identified previously (29,35-38), including the rim of the implant (29,37,38), despite undetectable levels of free radicals. The implant rim is exposed to lipid-rich synovial fluid, a potential *in vivo* polyethylene oxidant (37,48,49). It is interesting to note that retrieved remelted liners demonstrated no appreciable difference in crystallinity compared to the material bulk or the control liners. Surface microcracking was found in only one remelted liner which had no detectable level of rim oxidation. Crystallinity was equivalent in retrieved remelted liners with $OI_{max} > 0.1$ compared to those with no detectable oxidation. Furthermore, the hardness of these samples was similar regardless of the presence of oxidation, and were both elevated by ~6% compared to control liners. The previous mechanical testing study demonstrated an increase in hardness of ~14% in this liner type after extended *in vivo* time. Oral *et al* (5,48) found that the mechanical properties of remelted HXLPE became compromised at OI values as low as 0.1, with ultimate tensile strength and cross-link density decreasing rapidly along with an associated increase in elastic modulus, proposing that oxidation of tie chain molecules found in the amorphous region and short

chain recrystallization secondary to chain scission would decrease the tensile strength and elastic modulus, respectively (5). Fung *et al* (50) found critical oxidation for numerous mechanical properties to be at $OI < 1$ in remelted HXLPE liners. Though a significant increase in hardness was found in the prior investigation, oxidation and a subsequent increased crystallinity do not seem to be driving this change in hardness after *in vivo* exposure based on the results of the current study. Given that remelted HXLPE demonstrates inferior mechanical behavior compared to single or sequentially annealed HXLPE due to reduced crystallinity (6,10,11) and that most of the reported mechanical failures of THA liner rims occurred in remelted HXLPE liners (21-28), continued investigation into the causes of this degradation in mechanical behavior is necessary to determine its significance.

Oxidation of the articular surface was found in all retrieved single and sequentially annealed liners and 62.5% of retrieved remelted liners. Articular surface oxidation levels were highest in the single annealed liners (average $OI_{max}=1$) and lower in the sequentially annealed (average $OI_{max}=0.3$) and remelted (average $OI_{max}=0.2$) liners. It has previously been proposed that the femoral head may play a partially protective role against oxidation of the articular surface in HXLPE acetabular liners by protecting the surface from oxygen-rich synovial fluid (32,34), which is consistent with the lower overall extent of oxidation seen in the articular surface compared to the rim in this study. However, 81.3% of retrieved liners in this study demonstrating detectable articular surface oxidation compared to 56.3% of liner rims. Alternative modes of oxidation have been discovered including cyclic mechanical stress at the implant articular surface and oxidation of diffused synovial lipids as noted above (29,37,51). It is likely that a combination of these factors contributed to the frequency of articular surface oxidation seen in this study.

This study had a number of strengths. To our knowledge this is the first study to directly assess the oxidation, microstructural and mechanical properties of retrieved HXLPE acetabular liner rims, allowing for the direct assessment of the impacts of *in vivo* exposure on implant rim properties and mechanical behavior. This study included samples with greater average *in vivo* times than most current retrieval studies, allowing for an assessment of the long-term impact of *in vivo* use on implant properties and

behavior. This study utilized a validated (52), simple and non-destructive method of mechanically testing THA liner rims using a microindentation technique. *Ex vivo* time was also controlled for, reducing the risk of shelf oxidation in the retrieved samples. This study also has some limitations. This study had a small sample size for each cohort, limiting statistical analysis and study power. Samples were selected to maximize *in vivo* time, making assessment of the impact of time on *in vivo* changes difficult. Remelted liners came from multiple manufacturers with differences in radiation doses which has been shown to potentially influence oxidative stability and mechanical properties (5,50). Microindentation was performed along the rim surface, and given the limited depth of tip indentation, the ability to assess mechanical properties in the subsurface region may be limited and requires further experimental analysis.

This study has demonstrated the impact of prolonged *in vivo* exposure on the oxidative stability, microstructural and mechanical properties of retrieved HXLPE acetabular liner rims. *In vivo* exposure led to rim oxidation and increased crystallinity in single annealed and some sequentially annealed liners. Remelted liner rims did not demonstrate a significant difference in crystallinity, regardless of the presence of oxidation. Given the significant change in mechanical properties of retrieved remelted HXLPE liners found in the previously performed mechanical testing study, further investigation is needed to determine the cause and clinical significance of these findings.

6.5 References

1. Pezzotti G. Raman spectroscopy of biomedical polyethylenes. *Acta Biomater.* 2017;55:28-99. doi:10.1016/j.actbio.2017.03.015
2. Willert HG, Bertram H, Buchhorn GH. Osteolysis in alloarthroplasty of the hip. The role of ultra-high molecular weight polyethylene wear particles. *Clin Orthop Relat Res.* 1990;(258):95-107.
3. Cooper RA, McAllister CM, Borden LS, *et al.* Polyethylene debris-induced osteolysis and loosening in uncemented total hip arthroplasty. A cause of late failure. *J Arthroplasty.* 1992;7(3):285-290.
4. Ingham E, Fisher J. Biological reactions to wear debris in total joint replacement. *Proc Inst Mech Eng H.* 2000;214(1):21-37. doi:10.1243/0954411001535219

5. Oral E, Neils AL, Doshi BN, *et al.* Effects of simulated oxidation on the *in vitro* wear and mechanical properties of irradiated and melted highly crosslinked UHMWPE. *J Biomed Mater Res Part B Appl Biomater.* 2016;104(2):316-322. doi:10.1002/jbm.b.33368
6. Bracco P, Bellare A, Bistolfi A, *et al.* Ultra-High Molecular Weight Polyethylene: Influence of the Chemical, Physical and Mechanical Properties on the Wear Behavior. A Review. *Materials (Basel).* 2017;10(7). doi:10.3390/ma10070791
7. Kurtz SM, Zagorski M. 3 - Packaging and Sterilization of UHMWPE. In: *UHMWPE Biomaterials Handbook (Third Edition)*. Oxford: William Andrew Publishing; 2016:21-32. doi:10.1016/B978-0-323-35401-1.00003-X
8. Costa L, Bracco P. 26 - Mechanisms of Cross-Linking, Oxidative Degradation, and Stabilization of UHMWPE. In: Kurtz SM, ed. *UHMWPE Biomaterials Handbook (Third Edition)*. Oxford: William Andrew Publishing; 2016:467-487. doi:10.1016/B978-0-323-35401-1.00026-0
9. Muratoglu OK, Bragdon CR, O'Connor DO, *et al.* A novel method of cross-linking ultra-high-molecular-weight polyethylene to improve wear, reduce oxidation, and retain mechanical properties. Recipient of the 1999 HAP Paul Award. *J Arthroplasty.* 2001;16(2):149-160. doi:10.1054/arth.2001.20540
10. Muratoglu OK, Bragdon CR. 15 - Highly Cross-Linked and Melted UHMWPE. In: Kurtz SM, ed. *UHMWPE Biomaterials Handbook (Third Edition)*. Oxford: William Andrew Publishing; 2016:264-273. doi:10.1016/B978-0-323-35401-1.00015-6
11. Atwood SA, Van Citters DW, Patten EW, *et al.* Tradeoffs amongst fatigue, wear, and oxidation resistance of cross-linked ultra-high molecular weight polyethylene. *J Mech Behav Biomed Mater.* 2011;4(7):1033-1045. doi:10.1016/j.jmbbm.2011.03.012
12. Pruitt LA, Ansari F, Kury M, *et al.* Clinical trade-offs in cross-linked ultrahigh-molecular-weight polyethylene used in total joint arthroplasty. *J Biomed Mater Res Part B Appl Biomater.* 2013;101B. doi:10.1002/jbm.b.32887
13. Dumbleton JH, D'Antonio JA, Manley MT, *et al.* The basis for a second-generation highly cross-linked UHMWPE. *Clin Orthop Relat Res.* 2006;453:265-271. doi:10.1097/01.blo.0000238856.61862.7d
14. Jacobs CA, Christensen CP, Greenwald AS, *et al.* Clinical performance of highly cross-linked polyethylenes in total hip arthroplasty. *J Bone Joint Surg Am.* 2007;89(12):2779-2786. doi:10.2106/JBJS.G.00043
15. Lachiewicz PF, Soileau ES. Highly Cross-linked Polyethylene Provides Decreased Osteolysis and Reoperation at Minimum 10-Year Follow-Up. *J Arthroplasty.* 2016;31(9):1959-1962. doi:10.1016/j.arth.2016.02.038

16. Kurtz SM, Gawel HA, Patel JD. History and systematic review of wear and osteolysis outcomes for first-generation highly crosslinked polyethylene. *Clin Orthop Relat Res.* 2011;469(8):2262-2277. doi:10.1007/s11999-011-1872-4
17. Glyn-Jones S, Thomas GER, Garfield-Roberts P, *et al.* The John Charnley Award: Highly crosslinked polyethylene in total hip arthroplasty decreases long-term wear: a double-blind randomized trial. *Clin Orthop Relat Res.* 2015;473(2):432-438. doi:10.1007/s11999-014-3735-2
18. Paxton EW, Inacio MCS, Namba RS, *et al.* Metal-on-conventional polyethylene total hip arthroplasty bearing surfaces have a higher risk of revision than metal-on-highly crosslinked polyethylene: results from a US registry. *Clin Orthop Relat Res.* 2015;473(3):1011-1021. doi:10.1007/s11999-014-4105-9
19. Paxton E, Cafri G, Havelin L, *et al.* Risk of Revision Following Total Hip Arthroplasty: Metal-on-Conventional Polyethylene Compared with Metal-on-Highly Cross-Linked Polyethylene Bearing Surfaces: International Results from Six Registries. *J Bone Joint Surg Am.* 2014;96(Suppl 1):19-24. doi:10.2106/JBJS.N.00460
20. Hanna SA, Somerville L, McCalden RW, *et al.* Highly cross-linked polyethylene decreases the rate of revision of total hip arthroplasty compared with conventional polyethylene at 13 years' follow-up. *Bone Joint J.* 2016;98-B(1):28-32. doi:10.1302/0301-620X.98B1.36527
21. Hara D, Nakashima Y, Yamamoto T, *et al.* Late failure of annealed highly cross-linked polyethylene acetabular liner. *J Mech Behav Biomed Mater.* 2013;28:206-212. doi:10.1016/j.jmbbm.2013.08.003
22. Tower SS. Rim Cracking of the Cross-Linked Longevity Polyethylene Acetabular Liner After Total Hip Arthroplasty. *J Bone Joint Surg Am.* 2007;89(10):2212. doi:10.2106/JBJS.F.00758
23. Moore KD, Beck PR, Petersen DW, *et al.* Early Failure of a Cross-Linked Polyethylene Acetabular Liner: A Case Report. *J Bone Joint Surg Am.* 2008;90(11):2499-2504. doi:10.2106/JBJS.G.01304
24. Waewsawangwong W, Goodman SB. Unexpected Failure of Highly Cross-Linked Polyethylene Acetabular Liner. *J Arthroplasty.* 2012;27(2):323.e1-323.e4. doi:10.1016/j.arth.2011.04.010
25. Ast MP, John TK, Labbisiere A, *et al.* Fractures of a single design of highly cross-linked polyethylene acetabular liners: an analysis of voluntary reports to the United States Food and Drug Administration. *J Arthroplasty.* 2014;29(6):1231-1235. doi:10.1016/j.arth.2013.12.022

26. Duffy GP, Wannomae KK, Rowell SL, *et al.* Fracture of a Cross-Linked Polyethylene Liner Due to Impingement. *J Arthroplasty.* 2009;24(1):158.e15-158.e19. doi:10.1016/j.arth.2007.12.020
27. Furmanski J, Anderson M, Bal S, *et al.* Clinical fracture of cross-linked UHMWPE acetabular liners. *Biomaterials.* 2009;30(29):5572-5582. doi:10.1016/j.biomaterials.2009.07.013
28. Blumenfeld TJ, McKellop HA, Schmalzried TP, *et al.* Fracture of a Cross-Linked Polyethylene Liner. *J Arthroplasty.* 2011;26(4):666.e5-666.e8. doi:10.1016/j.arth.2010.07.009
29. MacDonald D, Sakona A, Ianuzzi A, *et al.* Do First-generation Highly Crosslinked Polyethylenes Oxidize *In vivo*? *Clin Orthop Relat Res.* 2011;469(8):2278-2285. doi:10.1007/s11999-010-1728-3
30. Wannomae KK, Bhattacharyya S, Freiberg A, *et al.* *In vivo* oxidation of retrieved cross-linked ultra-high-molecular-weight polyethylene acetabular components with residual free radicals. *J Arthroplasty.* 2006;21(7):1005-1011. doi:10.1016/j.arth.2005.07.019
31. Currier BH. Evaluation of Oxidation and Fatigue Damage of Retrieved Crossfire Polyethylene Acetabular Cups. *J Bone Joint Surg Am.* 2007;89(9):2023. doi:10.2106/JBJS.F.00336
32. Kurtz SM, Hozack W, Turner J, *et al.* Mechanical Properties of Retrieved Highly Cross-Linked Crossfire Liners After Short-Term Implantation. *J Arthroplasty.* 2005;20(7):840-849. doi:10.1016/j.arth.2005.07.015
33. Kurtz SM, Austin MS, Azzam K, *et al.* Mechanical Properties, Oxidation, and Clinical Performance of Retrieved Highly Cross-Linked Crossfire Liners After Intermediate-Term Implantation. *J Arthroplasty.* 2010;25(4):614-623.e2. doi:10.1016/j.arth.2009.04.022
34. Kurtz SM, Hozack WJ, Purtill JJ, *et al.* 2006 Otto Aufranc Award Paper: Significance of *In vivo* Degradation for Polyethylene in Total Hip Arthroplasty: *Clin Orthop Relat Res.* 2006;453:47-57. doi:10.1097/01.blo.0000246547.18187.0b
35. Currier BH, Van Citters DW, Currier JH, *et al.* *In vivo* Oxidation in Remelted Highly Cross-Linked Retrievals: *J Bone Joint Surg Am.* 2010;92(14):2409-2418. doi:10.2106/JBJS.I.01006
36. Miura Y, Hasegawa M, Sudo A, *et al.* In-vivo degradation of middle-term highly cross-linked and remelted polyethylene cups: Modification induced by creep, wear and oxidation. *J Mech Behav Biomed Mater.* 2015;51:13-24. doi:10.1016/j.jmbbm.2015.06.028

37. Muratoglu OK, Wannomae KK, Rowell SL, *et al.* *Ex vivo* stability loss of irradiated and melted ultra-high molecular weight polyethylene. *J Bone Joint Surg Am.* 2010;92(17):2809-2816. doi:10.2106/JBJS.I.01017
38. Rowell SL, Reyes CR, Malchau H, *et al.* *In vivo* Oxidative Stability Changes of Highly Cross-Linked Polyethylene Bearings: An *Ex vivo* Investigation. *J Arthroplasty.* 2015;30(10):1828-1834. doi:10.1016/j.arth.2015.05.006
39. Wernlé JD, Gilbert JL. Micromechanics of shelf-aged and retrieved UHMWPE tibial inserts: indentation testing, oxidative profiling, and thickness effects. *J Biomed Mater Res Part B Appl Biomater.* 2005;75(1):113-121. doi:10.1002/jbm.b.30285
40. Gilbert JL, Merkhani I. Rate effects on the microindentation-based mechanical properties of oxidized, crosslinked, and highly crystalline ultrahigh-molecular-weight polyethylene. *J Biomed Mater Res A.* 2004;71(3):549-558. doi:10.1002/jbm.a.30196
41. Collier JP, Currier BH, Kennedy FE, *et al.* Comparison of cross-linked polyethylene materials for orthopaedic applications. *Clin Orthop Relat Res.* 2003;(414):289-304. doi:10.1097/01.blo.0000073343.50837.03
42. Puppulin L, Miura Y, Casagrande E, *et al.* Validation of a protocol based on Raman and infrared spectroscopies to nondestructively estimate the oxidative degradation of UHMWPE used in total joint arthroplasty. *Acta Biomater.* 2016;38:168-178. doi:10.1016/j.actbio.2016.04.040
43. Strobl GR, Hagedorn W. Raman spectroscopic method for determining the crystallinity of polyethylene. *J Polym Sci B Polym Phys.* 16(7):1181-1193. doi:10.1002/pol.1978.180160704
44. Glotin M, Mandelkern L. A Raman spectroscopic study of the morphological structure of the polyethylenes. *Colloid & Polymer Sci.* 1982;260(2):182-192. doi:10.1007/BF01465438
45. Kurtz SM, MacDonald DW, Mont MA, *et al.* Retrieval analysis of sequentially annealed highly crosslinked polyethylene used in total hip arthroplasty. *Clin Orthop Relat Res.* 2015;473(3):962-971. doi:10.1007/s11999-014-4113-9
46. Reinitz SD, Currier BH, Van Citters DW, *et al.* Oxidation and other property changes of retrieved sequentially annealed UHMWPE acetabular and tibial bearings. *J Biomed Mater Res Part B Appl Biomater.* 2015;103(3):578-586. doi:10.1002/jbm.b.33240
47. Zhang P, Li SX, Zhang ZF. General relationship between strength and hardness. *Materials Science and Engineering: A.* 2011;529:62-73. doi:10.1016/j.msea.2011.08.061

48. Oral E, Ghali BW, Neils A, *et al.* A new mechanism of oxidation in ultrahigh molecular weight polyethylene caused by squalene absorption. *J Biomed Mater Res Part B Appl Biomater.* 2012;100(3):742-751. doi:10.1002/jbm.b.32507
49. Costa L, Bracco P, del Prever EB, *et al.* Analysis of products diffused into UHMWPE prosthetic components *in vivo.* *Biomaterials.* 2001;22(4):307-315.
50. Fung M, Bowsher JG, Van Citters DW. Variation of mechanical properties and oxidation with radiation dose and source in highly crosslinked remelted UHMWPE. *J Mech Behav Biomed Mater.* 2018;82:112-119. doi:10.1016/j.jmbbm.2018.03.005
51. Medel F, Kurtz S, MacDonald D, *et al.* Does cyclic stress play a role in highly crosslinked polyethylene oxidation? *Clin Orthop Relat Res.* 2015;473(3):1022-1029. doi:10.1007/s11999-015-4153-9
52. Singh G. Mechanical Properties of Retrieved Highly Cross-linked Polyethylene Acetabular Liners in Total Hip Arthroplasty. 2017. <https://ir.lib.uwo.ca/etd/4667>

Chapter 7

7 Discussion

7.1 Discussion and Conclusions

THA has proven to be an exceptionally successful surgical procedure in providing significant pain reduction and improved physical function in patients with end stage arthritis of the hip (1). Ultra-high molecular weight polyethylene (UHMWPE) is the bearing surface of choice in modern THA designs. However, the success of conventional UHMWPE has been limited by the long term material wear and the complications it creates, such as osteolysis (3-5). Highly cross-linked polyethylene (HXLPE) bearing surfaces have mitigated these complications, providing a significant reduction wear and wear-related revision surgeries (6-12). The radiation used as part of the HXLPE cross-linking process leads to polyethylene chain scission and formation highly reactive free radicals that can oxidize and create to a self-perpetuating oxidation process. This ultimately leads to significant material degradation and changes in implant properties (13-15). Thermal free radical stabilization processes by means of remelting or annealing were introduced to HXLPE production to reduce or eliminate these reactive species. Remelting results in undetectable levels of free radicals but an overall decreased ultimate strength, yield strength, and fatigue resistance (13,16,17), whereas annealing preserves mechanical properties while leaving residual free radicals with oxidative potential (18,19).

In chapter two of this thesis, the literature regarding *in vitro* testing and retrieval analysis of the physical and mechanical properties of remelted and annealed HXLPE liners was reviewed. A number of retrieval studies have found evidence of *in vivo* oxidation of annealed HXLPE acetabular liners, in particular at the implant rim (20-25). Likewise, *in vivo* oxidation of remelted polyethylene at both the articular surface and rim has been detected despite undetectable levels of free radicals (20,26-29). Furthermore, there have been a number of reports of mechanical failure of HXLPE acetabular liners at the implant rim leading to revision surgery (30-37). Despite reports of mechanical failures and evidence of *in vivo* oxidation, little is known about the mechanical properties of retrieved

HXLPE liner rims subsequent to being *in vivo* (38). The purpose of this thesis was to determine how different methods of thermal free radical stabilization impact the mechanical and physical properties of retrieved HXLPE liners after prolonged *in vivo* time.

In chapter four, the methodology used for this thesis was reviewed. For testing of mechanical properties, depth sensing indentation (DSI) was selected, specifically Vickers microindentation. This test assesses the hardness of a material, a property that increases with UHMWPE oxidation. This method is simple, able to be performed without sample destruction or alteration, and has the ability to measure larger regions accounting for both crystalline and amorphous regions of the polymer within a single indentation. Fourier transform infrared spectroscopy was chosen for the assessment of oxidation in this thesis as it is the gold standard in biomedical UHMWPE oxidation assessment (39) and would allow for direct comparison of the results to the current body of literature on *in vivo* oxidation. Raman spectroscopy was chosen for assessment of the crystallinity in this thesis as it has been previously validated for this purpose in biomedical UHMWPE (40-44) and could be performed without destruction of the sample. Crystallinity increases when UHMWPE is oxidized.

In chapter five, the results of the mechanical testing arm of this thesis are presented, with the goal of determining if extended *in vivo* time lead to a change in the mechanical properties of HXLPE liners based on the method of free radical stabilization. Based on the current body of literature, it was hypothesized that annealed (single or sequential) HXLPE liners would demonstrate rim mechanical property degradation as evident by an increased hardness given the increased residual free radical content and likelihood of *in vivo* oxidation, and that remelted HXLPE liners would not demonstrate a significant change in hardness. These results, while accounting for the potential impact of *ex vivo* time (which could lead to shelf oxidation), demonstrated that remelted liners had a significant increase in hardness after extended *in vivo* time, whereas single and sequentially annealed liners had minimal to no change, ultimately rejecting the hypothesis.

In chapter six, a subgroup of the retrieved HXLPE liners from the mechanical testing arm was assessed for evidence of oxidation and changes in crystallinity that may explain the hardness testing findings. A subgroup was selected with the highest *in vivo* times while also having *ex vivo* times below one year to reduce the potential impact of *ex vivo* time, if any, on the results. All three thermal free radical stabilization cohorts were assessed. Given the current knowledge about how microindentation hardness correlates with oxidation and crystallinity, it was hypothesized that there would be detectable oxidation and subsequent increased crystallinity in remelted HXLPE liners. Though limited evidence of detectable oxidation at the rim of retrieved remelted liners was found, there was no appreciable change in the crystallinity of these samples. Furthermore, the single and sequentially annealed liners exhibited more oxidation and increased crystallinity despite having relatively stable hardness values in the mechanical testing arm. The hypothesis regarding the association of hardness to oxidation and crystallinity in these retrieved liner cohorts was rejected, though this should warrant a broader investigation given the sample size and selection bias towards the most aged implants.

In conclusion, remelted HXLPE liners showed a degradation of mechanical properties, as assessed by hardness, after *in vivo* exposure over 4.5 years. However, single and sequentially annealed liners had relatively stable mechanical properties. In remelted liners, these changes occur despite the samples being generally more oxidatively stable and with no significant change in their crystallinity. Single and sequentially annealed liners, on the other hand, demonstrated increased oxidation and crystallinity after extended *in vivo* time but relatively stable mechanical properties. This is the first study to our knowledge assessing both mechanical and physical properties of retrieved HXLPE liner rims. Though it is likely that the mechanical failures seen in predominantly remelted HXLPE liners is indeed multifactorial (19,30-37), mechanical property degradation of remelted HXLPE liners does occur with long-term *in vivo* exposure and should be considered a potential risk factor, though the mechanism of this degradation is not clearly explained by oxidation and crystallinity changes.

7.2 Future Directions

One of the next steps for DSI testing of retrieved HXLPE liners will be to determine an objective, clinically significant threshold for changes in microindentation hardness for liners processed with different thermal stabilization techniques. It is important to determine to what extent hardness can change before mechanical failure is possible, and if the amount of change in hardness differs based on how the implants were manufactured. With the finding that remelted liners, with already inferior mechanical properties compared to other HXLPE formulations, do indeed demonstrate mechanical property degradation *in vivo*, another phase of this study should include assessment of other physical properties of retrieved remelted liner rims with extended *in vivo* time. Recent studies have found that the mechanical properties of remelted liners may be compromised at significantly lower levels of oxidation than previously thought possible (45,46), which may lead to more subtle changes in the microstructure of the polyethylene resulting in mechanical property degradation. Given the paucity of literature in the mechanical properties of the acetabular rim, determination of these rim properties in retrieved HXLPE liners that mechanically failed would be extremely useful. There remains the opportunity to assess the role of other factors on mechanical property changes such as cross-linking radiation dose, variability in the implant rim morphology, or testing the different regions of the implant rim which may be under different oxidative and mechanical stresses. Additionally, the role of patient-specific factors on *in vivo* property changes remains an area of interest and warrants further exploration.

7.3 References

1. Learmonth ID, Young C, Rorabeck C. The operation of the century: total hip replacement. *The Lancet*. 2007;370(9597):1508-1519. doi:10.1016/S0140-6736(07)60457-7
2. Charnley J. Arthroplasty of the hip. A new operation. *Lancet*. 1961;1(7187):1129-1132.
3. Willert HG, Bertram H, Buchhorn GH. Osteolysis in alloarthroplasty of the hip. The role of ultra-high molecular weight polyethylene wear particles. *Clin Orthop Relat Res*. 1990;(258):95-107.

4. Cooper RA, McAllister CM, Borden LS, *et al.* Polyethylene debris-induced osteolysis and loosening in uncemented total hip arthroplasty. A cause of late failure. *J Arthroplasty*. 1992;7(3):285-290.
5. Ingham E, Fisher J. Biological reactions to wear debris in total joint replacement. *Proc Inst Mech Eng H*. 2000;214(1):21-37. doi:10.1243/0954411001535219
6. Jacobs CA, Christensen CP, Greenwald AS, *et al.* Clinical performance of highly cross-linked polyethylenes in total hip arthroplasty. *J Bone Joint Surg Am*. 2007;89(12):2779-2786. doi:10.2106/JBJS.G.00043
7. Lachiewicz PF, Soileau ES. Highly Cross-linked Polyethylene Provides Decreased Osteolysis and Reoperation at Minimum 10-Year Follow-Up. *J Arthroplasty*. 2016;31(9):1959-1962. doi:10.1016/j.arth.2016.02.038
8. Kurtz SM, Gawel HA, Patel JD. History and systematic review of wear and osteolysis outcomes for first-generation highly crosslinked polyethylene. *Clin Orthop Relat Res*. 2011;469(8):2262-2277. doi:10.1007/s11999-011-1872-4
9. Glyn-Jones S, Thomas GER, Garfjeld-Roberts P, *et al.* The John Charnley Award: Highly crosslinked polyethylene in total hip arthroplasty decreases long-term wear: a double-blind randomized trial. *Clin Orthop Relat Res*. 2015;473(2):432-438. doi:10.1007/s11999-014-3735-2
10. Paxton EW, Inacio MCS, Namba RS, *et al.* Metal-on-conventional polyethylene total hip arthroplasty bearing surfaces have a higher risk of revision than metal-on-highly crosslinked polyethylene: results from a US registry. *Clin Orthop Relat Res*. 2015;473(3):1011-1021. doi:10.1007/s11999-014-4105-9
11. Paxton E, Cafri G, Havelin L, *et al.* Risk of Revision Following Total Hip Arthroplasty: Metal-on-Conventional Polyethylene Compared with Metal-on-Highly Cross-Linked Polyethylene Bearing Surfaces: International Results from Six Registries. *J Bone Joint Surg Am*. 2014;96(Suppl 1):19-24. doi:10.2106/JBJS.N.00460
12. Hanna SA, Somerville L, McCalden RW, *et al.* Highly cross-linked polyethylene decreases the rate of revision of total hip arthroplasty compared with conventional polyethylene at 13 years' follow-up. *Bone Joint J*. 2016;98-B(1):28-32. doi:10.1302/0301-620X.98B1.36527
13. Bracco P, Bellare A, Bistolfi A, *et al.* Ultra-High Molecular Weight Polyethylene: Influence of the Chemical, Physical and Mechanical Properties on the Wear Behavior. A Review. *Materials (Basel)*. 2017;10(7). doi:10.3390/ma10070791
14. Kurtz SM, Zagorski M. 3 - Packaging and Sterilization of UHMWPE. In: *UHMWPE Biomaterials Handbook (Third Edition)*. Oxford: William Andrew Publishing; 2016:21-32. doi:10.1016/B978-0-323-35401-1.00003-X

15. Costa L, Bracco P. 26 - Mechanisms of Cross-Linking, Oxidative Degradation, and Stabilization of UHMWPE. In: Kurtz SM, ed. *UHMWPE Biomaterials Handbook (Third Edition)*. Oxford: William Andrew Publishing; 2016:467-487. doi:10.1016/B978-0-323-35401-1.00026-0
16. Muratoglu OK, Bragdon CR, O'Connor DO, *et al.* A novel method of cross-linking ultra-high-molecular-weight polyethylene to improve wear, reduce oxidation, and retain mechanical properties. Recipient of the 1999 HAP Paul Award. *J Arthroplasty*. 2001;16(2):149-160. doi:10.1054/arth.2001.20540
17. Muratoglu OK, Bragdon CR. 15 - Highly Cross-Linked and Melted UHMWPE. In: Kurtz SM, ed. *UHMWPE Biomaterials Handbook (Third Edition)*. Oxford: William Andrew Publishing; 2016:264-273. doi:10.1016/B978-0-323-35401-1.00015-6
18. Atwood SA, Van Citters DW, Patten EW, *et al.* Tradeoffs amongst fatigue, wear, and oxidation resistance of cross-linked ultra-high molecular weight polyethylene. *J Mech Behav Biomed Mater*. 2011;4(7):1033-1045. doi:10.1016/j.jmbbm.2011.03.012
19. Pruitt LA, Ansari F, Kury M, *et al.* Clinical trade-offs in cross-linked ultrahigh-molecular-weight polyethylene used in total joint arthroplasty. *J Biomed Mater Res Part B Appl Biomater*. 2013;101B. doi:10.1002/jbm.b.32887
20. MacDonald D, Sakona A, Ianuzzi A, *et al.* Do First-generation Highly Crosslinked Polyethylenes Oxidize *In vivo*? *Clin Orthop Relat Res*. 2011;469(8):2278-2285. doi:10.1007/s11999-010-1728-3
21. Wannomae KK, Bhattacharyya S, Freiberg A, *et al.* *In vivo* oxidation of retrieved cross-linked ultra-high-molecular-weight polyethylene acetabular components with residual free radicals. *J Arthroplasty*. 2006;21(7):1005-1011. doi:10.1016/j.arth.2005.07.019
22. Currier BH. Evaluation of Oxidation and Fatigue Damage of Retrieved Crossfire Polyethylene Acetabular Cups. *J Bone Joint Surg Am*. 2007;89(9):2023. doi:10.2106/JBJS.F.00336
23. Kurtz SM, Hozack W, Turner J, *et al.* Mechanical Properties of Retrieved Highly Cross-Linked Crossfire Liners After Short-Term Implantation. *J Arthroplasty*. 2005;20(7):840-849. doi:10.1016/j.arth.2005.07.015
24. Kurtz SM, Austin MS, Azzam K, *et al.* Mechanical Properties, Oxidation, and Clinical Performance of Retrieved Highly Cross-Linked Crossfire Liners After Intermediate-Term Implantation. *J Arthroplasty*. 2010;25(4):614-623.e2. doi:10.1016/j.arth.2009.04.022
25. Kurtz SM, Hozack WJ, Purtill JJ, *et al.* 2006 Otto Aufranc Paper Award: Significance of *In vivo* Degradation for Polyethylene in Total Hip Arthroplasty: *Clin Orthop Relat Res*. 2006;453:47-57. doi:10.1097/01.blo.0000246547.18187.0b

26. Currier BH, Van Citters DW, Currier JH, *et al.* *In vivo* Oxidation in Remelted Highly Cross-Linked Retrievals: *J Bone Joint Surg Am.* 2010;92(14):2409-2418. doi:10.2106/JBJS.I.01006
27. Miura Y, Hasegawa M, Sudo A, *et al.* In-vivo degradation of middle-term highly cross-linked and remelted polyethylene cups: Modification induced by creep, wear and oxidation. *J Mech Behav Biomed Mater.* 2015;51:13-24. doi:10.1016/j.jmbbm.2015.06.028
28. Muratoglu OK, Wannomae KK, Rowell SL, *et al.* *Ex vivo* stability loss of irradiated and melted ultra-high molecular weight polyethylene. *J Bone Joint Surg Am.* 2010;92(17):2809-2816. doi:10.2106/JBJS.I.01017
29. Rowell SL, Reyes CR, Malchau H, *et al.* *In vivo* Oxidative Stability Changes of Highly Cross-Linked Polyethylene Bearings: An *Ex vivo* Investigation. *J Arthroplasty.* 2015;30(10):1828-1834. doi:10.1016/j.arth.2015.05.006
30. Hara D, Nakashima Y, Yamamoto T, *et al.* Late failure of annealed highly cross-linked polyethylene acetabular liner. *J Mech Behav Biomed Mater.* 2013;28:206-212. doi:10.1016/j.jmbbm.2013.08.003
31. Tower SS. Rim Cracking of the Cross-Linked Longevity Polyethylene Acetabular Liner After Total Hip Arthroplasty. *J Bone Joint Surg Am.* 2007;89(10):2212. doi:10.2106/JBJS.F.00758
32. Moore KD, Beck PR, Petersen DW, *et al.* Early Failure of a Cross-Linked Polyethylene Acetabular Liner: A Case Report. *J Bone Joint Surg Am.* 2008;90(11):2499-2504. doi:10.2106/JBJS.G.01304
33. Waewsawangwong W, Goodman SB. Unexpected Failure of Highly Cross-Linked Polyethylene Acetabular Liner. *J Arthroplasty.* 2012;27(2):323.e1-323.e4. doi:10.1016/j.arth.2011.04.010
34. Ast MP, John TK, Labbisiere A, *et al.* Fractures of a single design of highly cross-linked polyethylene acetabular liners: an analysis of voluntary reports to the United States Food and Drug Administration. *J Arthroplasty.* 2014;29(6):1231-1235. doi:10.1016/j.arth.2013.12.022
35. Duffy GP, Wannomae KK, Rowell SL, *et al.* Fracture of a Cross-Linked Polyethylene Liner Due to Impingement. *J Arthroplasty.* 2009;24(1):158.e15-158.e19. doi:10.1016/j.arth.2007.12.020
36. Furmanski J, Anderson M, Bal S, *et al.* Clinical fracture of cross-linked UHMWPE acetabular liners. *Biomaterials.* 2009;30(29):5572-5582. doi:10.1016/j.biomaterials.2009.07.013

37. Blumenfeld TJ, McKellop HA, Schmalzried TP, *et al.* Fracture of a Cross-Linked Polyethylene Liner. *J Arthroplasty*. 2011;26(4):666.e5-666.e8. doi:10.1016/j.arth.2010.07.009
38. Singh G. Mechanical Properties of Retrieved Highly Cross-linked Polyethylene Acetabular Liners in Total Hip Arthroplasty. 2017. <https://ir.lib.uwo.ca/etd/4667>.
39. Kurtz SM, Muratoglu OK, Buchanan FJ, *et al.* Interlaboratory studies to determine optimal analytical methods for measuring the oxidation index of UHMWPE. *Biomaterials*. 2001;22(21):2875-2881. doi:10.1016/S0142-9612(01)00033-3
40. Strobl GR, Hagedorn W. Raman spectroscopic method for determining the crystallinity of polyethylene. *J Polym Sci B Polym Phys*. 16(7):1181-1193. doi:10.1002/pol.1978.180160704
41. Rull F, Prieto AC, Casado JM, *et al.* Estimation of crystallinity in polyethylene by Raman spectroscopy. *J Raman Spectrosc*. 24(8):545-550. doi:10.1002/jrs.1250240813
42. Taddei P, Affatato S, Fagnano C, *et al.* Vibrational spectroscopy of ultra-high molecular weight polyethylene hip prostheses: influence of the sterilisation method on crystallinity and surface oxidation. *Journal of Molecular Structure*. 2002;613(1):121-129. doi:10.1016/S0022-2860(02)00141-2
43. Bertoluzza A, Fagnano C, Rossi M, *et al.* Micro-Raman spectroscopy for the crystallinity characterization of UHMWPE hip cups run on joint simulators. *Journal of Molecular Structure*. 2000;521(1):89-95. doi:10.1016/S0022-2860(99)00427-5
44. Puppulin L, Kumakura T, Yamamoto K, *et al.* Structural profile of ultra-high molecular weight polyethylene in acetabular cups worn on hip simulators characterized by confocal Raman spectroscopy. *J Orthop Res*. 29(6):893-899. doi:10.1002/jor.21331
45. Oral E, Neils AL, Doshi BN, *et al.* Effects of simulated oxidation on the *in vitro* wear and mechanical properties of irradiated and melted highly crosslinked UHMWPE. *J Biomed Mater Res Part B Appl Biomater*. 2016;104(2):316-322. doi:10.1002/jbm.b.33368
46. Fung M, Bowsher JG, Van Citters DW. Variation of mechanical properties and oxidation with radiation dose and source in highly crosslinked remelted UHMWPE. *J Mech Behav Biomed Mater*. 2018;82:112-119. doi:10.1016/j.jmbbm.2018.03.005

Appendix A - Patient Data for Retrieved HXLPE Liners (Chapter 5)

Appendix A - Patient Data for Retrieved HXLPE Liners (Chapter 5)

ID	Patient Gender	Patient Age	Manufacturer	HXLPE Material	Thermal Stabilization	Indication for Revision	<i>In vivo</i> Time (Years)	<i>Ex vivo</i> Time (Years)
H103	F	44.28	Depuy	Marathon	Remelted	Periprosthetic Fracture	4.6	11.6
H354	F	91.71	Stryker	Crossfire	Single Annealed	Periprosthetic Fracture	4.76	8.61
H137	F	83.89	Stryker	Crossfire	Single Annealed	Aseptic Loosening	4.85	6.72
H1320	F	71.1	Stryker	Crossfire	Single Annealed	Aseptic Loosening	4.91	5.9
H799	M	65.71	Stryker	Crossfire	Single Annealed	Aseptic Loosening	5	8.6
H1335	M	43.73	Stryker	X3	Sequentially Annealed	Undiagnosed Pain	5.17	3.64
H1262	F	67.81	Stryker	X3	Sequentially Annealed	Aseptic Loosening	5.18	3.92
H1633	M	66.7	Stryker	X3	Sequentially Annealed	Rejuvenate	5.2	2.29
H1519	M	71.96	Stryker	X3	Sequentially Annealed	Component Malposition	5.32	2.49
H1486	M	66.45	Zimmer	Longevity	Remelted	Aseptic Loosening	5.37	3.43
H1997	M	65.77	Stryker	Crossfire	Single Annealed	Trunnionosis	5.4	0.58
H140	M	68.98	Depuy	Marathon	Remelted	Periprosthetic Fracture	5.52	7.55
H1872	M	46.99	Stryker	X3	Sequentially Annealed	Infection	5.63	0.69
H2008	M	67.85	Depuy	AltrX	Remelted	Infection	5.88	0.57
H998	M	60.81	Stryker	Crossfire	Single Annealed	Aseptic Loosening	5.9	5.63
H907	F	76.3	Stryker	Crossfire	Single Annealed	Infection	5.91	5.72
H1631	F	73.64	Stryker	X3	Sequentially Annealed	Undiagnosed Pain	6.02	2.11
H784	M	68.37	Stryker	Crossfire	Single Annealed	Instability	6.07	6.26
H1825	F	54.95	Stryker	X3	Sequentially Annealed	Rejuvenate	6.14	1.02

H1049	M	58.05	Smith & Nephew	XLPE	Remelted	Infection	6.19	6.43
H1179	F	69.26	Zimmer	Longevity	Remelted	Instability	6.24	4.56
H1753	M	71.76	Stryker	X3	Sequentially Annealed	Rejuvenate	6.25	1.27
H882	M	78.95	Smith & Nephew	XLPE	Remelted	Instability	6.35	5.94
H1945	M	61.84	Stryker	X3	Sequentially Annealed	Rejuvenate	6.48	0.75
H1308	F	80.48	Stryker	Crossfire	Single Annealed	Infection	6.57	3.51
H1063	M	64.43	Stryker	X3	Sequentially Annealed	Aseptic Loosening	6.77	5.09
H1910	M	76.04	Stryker	X3	Sequentially Annealed	Undiagnosed Pain	6.79	0.84
H1780	F	42.08	Depuy	AltrX	Remelted	Instability	7	1.88
H243	F	66.77	Depuy	Marathon	Remelted	Instability	7.13	9.57
H1172	M	52.04	Zimmer	Longevity	Remelted	Infection	7.26	4.82
H1529	M	74.28	Stryker	X3	Sequentially Annealed	Aseptic Loosening	7.41	2.41
H1924	F	70.8	Zimmer	Longevity	Remelted	Undiagnosed Pain	7.48	0.69
H1301	M	82.46	Stryker	X3	Sequentially Annealed	Component Malposition	7.54	3.76
H1270	F	60.32	Stryker	X3	Sequentially Annealed	Aseptic Loosening	7.79	4.05
H1600	F	80.09	Stryker	Crossfire	Single Annealed	Aseptic Loosening	7.84	1.98
H1821	F	55.72	Stryker	X3	Sequentially Annealed	Infection	8.08	1.02
H1108	M	70.01	Smith & Nephew	XLPE	Remelted	Instability	8.12	5.26
H1921	M	73.65	Zimmer	Longevity	Remelted	Infection	8.56	0.57
H1139	M	80	Smith & Nephew	XLPE	Remelted	Instability	8.6	4.78
H1919	M	54.17	Depuy	AltrX	Remelted	Instability	8.61	0.73
H1117	M	61.51	Smith & Nephew	XLPE	Remelted	Infection	8.61	4.99
H1186	F	83.63	Stryker	Crossfire	Single Annealed	Infection	8.67	4.74
H1350	M	70.4	Zimmer	Longevity	Remelted	Infection	9.08	3.01
H1134	M	47.62	Smith & Nephew	XLPE	Remelted	Infection	9.25	5.05
H1521	F	76.04	Stryker	Crossfire	Single Annealed	Periprosthetic Fracture	9.43	2.7

H1261	M	72.58	Smith & Nephew	XLPE	Remelted	Periprosthetic Fracture	10.52	4.92
H1598	M	88.78	Smith & Nephew	XLPE	Remelted	Periprosthetic Fracture	11.64	2.32
H1286	F	83	Stryker	X3	Sequentially Annealed	Rejuvenate	11.88	5.03
H1784	M	76.01	Stryker	Crossfire	Single Annealed	Instability	11.89	1.24
H2010	M	85.79	Stryker	Crossfire	Single Annealed	Component Malposition	12.07	0.38
H1859	M	78.73	Stryker	Crossfire	Single Annealed	Polyethylene Wear	13.4	1.05
H1941	F	65.21	Smith & Nephew	XLPE	Remelted	Periprosthetic Fracture	13.74	0.46
H1988	M	80.64	Stryker	Crossfire	Single Annealed	Periprosthetic Fracture	14.01	0.33
H2025	F	65.37	Smith & Nephew	XLPE	Remelted	Undiagnosed Pain	7.93	0.38
H2045	F	78.40	Zimmer	Longevity	Remelted	Infection	8.30	0.25

Appendix B - Patient Data for Retrieved HXLPE Liners (Chapter 6)

Appendix B - Patient Data for Retrieved HXLPE Liners (Chapter 6)

ID	Patient Gender	Patient Age	Manufacturer	HXLPE Material	Thermal Stabilization	Indication for Revision	<i>In vivo</i> Time (Years)	<i>Ex vivo</i> Time (Years)
H1988	M	80.64	Stryker	Crossfire	Single Annealed	Periprosthetic Fracture	14.01	0.33
H1941	F	65.21	Smith & Nephew	XLPE	Remelted	Periprosthetic Fracture	13.74	0.46
H1859	M	78.73	Stryker	Crossfire	Single Annealed	Instability	13.4	1.05
H2010	M	85.79	Stryker	Crossfire	Single Annealed	Component Malposition	12.07	0.38
H1919	M	54.17	Depuy	AltrX	Remelted	Instability	8.61	0.73
H1921	M	73.65	Zimmer	Longevity	Remelted	Infection	8.56	0.57
H1924	F	70.8	Zimmer	Longevity	Remelted	Undiagnosed Pain	7.48	0.69
H1910	M	76.04	Stryker	X3	Sequentially Annealed	Undiagnosed Pain	6.79	0.84
H1945	M	61.84	Stryker	X3	Sequentially Annealed	Rejuvenate	6.48	0.75
H2008	M	67.85	Depuy	AltrX	Remelted	Infection	5.88	0.57
H1872	M	46.99	Stryker	X3	Sequentially Annealed	Infection	5.63	0.69
H1997	M	65.77	Stryker	Crossfire	Single Annealed	Trunnionosis	5.4	0.58
H2025	F	65.37	Smith & Nephew	XLPE	Remelted	Undiagnosed Pain	7.93	0.38
H2045	F	78.4	Zimmer	Longevity	Remelted	Infection	8.3	0.25
2980	M	53	Smith & Nephew	XLPE	Remelted	Aseptic Loosening	8.55	0
3380	F	81	Stryker	X3	Sequentially Annealed	Infection	9.45	0

Appendix C – Ethics Approvals

Appendix C - Ethics Approvals



**Western
Research**

Western University Health Science Research Ethics Board
HSREB Delegated Initial Approval Notice

Principal Investigator: Dr. Brent Lanting
Department & Institution: Schulich School of Medicine and Dentistry/Orthopaedic Surgery, London Health Sciences Centre

Review Type: Delegated
HSREB File Number: 108424
Study Title: Mechanical testing of retrieved acetabular liners from total hip arthroplasty

HSREB Initial Approval Date: October 17, 2016
HSREB Expiry Date: October 17, 2017

Documents Approved and/or Received for Information:

Document Name	Comments	Version Date
Western University Protocol	Received 2016/09/23	
Data Collection Form/Case Report Form	Implant data collection form - Received 2016/08/25	
Data Collection Form/Case Report Form	Demographic data collection form - Received 2016/08/25	

The Western University Health Science Research Ethics Board (HSREB) has reviewed and approved the above named study, as of the HSREB Initial Approval Date noted above.

HSREB approval for this study remains valid until the HSREB Expiry Date noted above, conditional to timely submission and acceptance of HSREB Continuing Ethics Review.

The Western University HSREB operates in compliance with the Tri-Council Policy Statement Ethical Conduct for Research Involving Humans (TCPS2), the International Conference on Harmonization of Technical Requirements for Registration of Pharmaceuticals for Human Use Guideline for Good Clinical Practice Practices (ICH E6 R1), the Ontario Personal Health Information Protection Act (PHIPA, 2004), Part 4 of the Natural Health Product Regulations, Health Canada Medical Device Regulations and Part C, Division 5, of the Food and Drug Regulations of Health Canada.

Members of the HSREB who are named as Investigators in research studies do not participate in discussions related to, nor vote on such studies when they are presented to the REB.

The HSREB is registered with the U.S. Department of Health & Human Services under the IRB registration number IRB 00000940.

Research Ethics



LAWSON FINAL APPROVAL NOTICE

LAWSON APPROVAL NUMBER: R-16-431

PROJECT TITLE: Mechanical testing of retrieved acetabular liners from total hip arthroplasty

PRINCIPAL INVESTIGATOR: Dr. Brent Lanting

LAWSON APPROVAL DATE: Friday, October 21, 2016

Health Sciences REB#: 108424

Please be advised that the above project was reviewed by the Clinical Research Impact Committee and Lawson Administration and the project:

Was Approved

Please provide your Lawson Approval Number (R#) to the appropriate contact(s) in supporting departments (eg. Lab Services, Diagnostic Imaging, etc.) to inform them that your study is starting. The Lawson Approval Number must be provided each time services are requested.

Dr. David Hill
V.P. Research
Lawson Health Research Institute

All future correspondence concerning this study should include the Lawson Approval Number and should be directed to Sherry Paiva, Research Approval Officer, Lawson Health Research Institute, 750 Baseline Road, East, Suite 300.

cc: Administration



Date: 8 February 2018

To: Brent Lanting

Project ID: 108424

Study Title: Mechanical testing and surface analysis of retrieved acetabular liners from total hip arthroplasty

Reference Number/ID: N/A

Application Type: HSREB Amendment Form

Review Type: Delegated

Full Board Reporting Date: 20Feb2018

Date Approval Issued: 08/Feb/2018 15:55

REB Approval Expiry Date: 17/Oct/2018

Dear Brent Lanting ,

The Western University Health Sciences Research Ethics Board (HSREB) has reviewed and approved the WREM application form for the amendment, as of the date noted above.

Documents Approved:

Document Name	Document Type	Document Date
108424 - Protocol 08-Feb-2018 CLEAN	Protocol	08/Feb/2018

REB members involved in the research project do not participate in the review, discussion or decision.

The Western University HSREB operates in compliance with, and is constituted in accordance with, the requirements of the TriCouncil Policy Statement: Ethical Conduct for Research Involving Humans (TCPS 2); the International Conference on Harmonisation Good Clinical Practice Consolidated Guideline (ICH GCP); Part C, Division 5 of the Food and Drug Regulations; Part 4 of the Natural Health Products Regulations; Part 3 of the Medical Devices Regulations and the provisions of the Ontario Personal Health Information Protection Act (PHIPA 2004) and its applicable regulations. The HSREB is registered with the U.S. Department of Health & Human Services under the IRB registration number IRB 00000940.

Please do not hesitate to contact us if you have any questions.

Sincerely,

Nicola Geoghegan-Morphet, Ethics Officer on behalf of Dr. Joseph Gilbert, HSREB Chair

Note: This correspondence includes an electronic signature (validation and approval via an online system that is compliant with all regulations).

Appendix D – Permissions for Tables and Figures

Appendix D - Permissions for Tables and Figures

RightsLink Printable License

6/17/18, 5:15 PM

WOLTERS KLUWER HEALTH LICENSE TERMS AND CONDITIONS

Jun 17, 2018

This Agreement between Dr. Michael Decker ("You") and Wolters Kluwer Health ("Wolters Kluwer Health") consists of your license details and the terms and conditions provided by Wolters Kluwer Health and Copyright Clearance Center.

License Number	4371550555683
License date	Jun 17, 2018
Licensed Content Publisher	Wolters Kluwer Health
Licensed Content Publication	WK Health Book
Licensed Content Title	The Adult Hip (Two Volume Set)
Licensed Content Author	John J. Callaghan , Aaron G. Rosenberg MD, Harry E. Rubash MD, John Clohisy MD, Paul Beaulé MD, Craig DellaValle MD
Licensed Content Date	Jan 1, 2015
Type of Use	Dissertation/Thesis
Requestor type	academic/educational
Format	print and electronic
Portion	figures/tables/illustrations
Number of figures/tables/illustrations	1
The ID numbers of the figures/tables/illustrations are...	figure 2.1
Will you be translating?	no
Reusing current or a previous edition	current edition
Circulation/distribution	50
Title of your thesis / dissertation	In Vivo Mechanical and Physical Property Changes in Highly Cross-Linked Polyethylene Acetabular Liners
Expected completion date	Nov 2018
Estimated size (number of pages)	100

**WOLTERS KLUWER HEALTH LICENSE
TERMS AND CONDITIONS**

Jun 17, 2018

This Agreement between Dr. Michael Decker ("You") and Wolters Kluwer Health ("Wolters Kluwer Health") consists of your license details and the terms and conditions provided by Wolters Kluwer Health and Copyright Clearance Center.

License Number	4371551105758
License date	Jun 17, 2018
Licensed Content Publisher	Wolters Kluwer Health
Licensed Content Publication	WK Health Book
Licensed Content Title	The Adult Hip (Two Volume Set)
Licensed Content Author	John J. Callaghan , Aaron G. Rosenberg MD, Harry E. Rubash MD, John Clohisy MD, Paul Beaulé MD, Craig DellaValle MD
Licensed Content Date	Jan 1, 2015
Type of Use	Dissertation/Thesis
Requestor type	academic/educational
Format	print and electronic
Portion	figures/tables/illustrations
Number of figures/tables/illustrations	1
The ID numbers of the figures/tables/illustrations are...	figure 11.2
Will you be translating?	no
Reusing current or a previous edition	current edition
Circulation/distribution	50
Title of your thesis / dissertation	In Vivo Mechanical and Physical Property Changes in Highly Cross-Linked Polyethylene Acetabular Liners
Expected completion date	Nov 2018
Estimated size (number of pages)	100

**WOLTERS KLUWER HEALTH, INC. LICENSE
TERMS AND CONDITIONS**

Jun 17, 2018

This Agreement between Dr. Michael Decker ("You") and Wolters Kluwer Health, Inc. ("Wolters Kluwer Health, Inc.") consists of your license details and the terms and conditions provided by Wolters Kluwer Health, Inc. and Copyright Clearance Center.

License Number	4371640697546
License date	Jun 17, 2018
Licensed Content Publisher	Wolters Kluwer Health, Inc.
Licensed Content Publication	Journal of Bone & Joint Surgery
Licensed Content Title	Rim Cracking of the Cross-Linked Longevity Polyethylene Acetabular Liner After Total Hip Arthroplasty
Licensed Content Author	Stephen Tower, John Currier, Barbara Currier, et al
Licensed Content Date	Oct 1, 2007
Licensed Content Volume	89
Licensed Content Issue	10
Type of Use	Dissertation/Thesis
Requestor type	Individual
STM publisher name	
Portion	Figures/table/illustration
Number of figures/tables/illustrations	1
Figures/tables/illustrations used	figure 1
Author of this Wolters Kluwer article	No
Title of your thesis / dissertation	In Vivo Mechanical and Physical Property Changes in Highly Cross-Linked Polyethylene Acetabular Liners
Expected completion date	Nov 2018
Estimated size(pages)	100

**ELSEVIER LICENSE
TERMS AND CONDITIONS**

Jun 17, 2018

This Agreement between Dr. Michael Decker ("You") and Elsevier ("Elsevier") consists of your license details and the terms and conditions provided by Elsevier and Copyright Clearance Center.

License Number	4371631479134
License date	Jun 17, 2018
Licensed Content Publisher	Elsevier
Licensed Content Publication	The Lancet
Licensed Content Title	Hip arthroplasty
Licensed Content Author	Robert Pivec,Aaron J Johnson,Simon C Mears,Michael A Mont
Licensed Content Date	17-23 November 2012
Licensed Content Volume	380
Licensed Content Issue	9855
Licensed Content Pages	10
Start Page	1768
End Page	1777
Type of Use	reuse in a thesis/dissertation
Intended publisher of new work	other
Portion	figures/tables/illustrations
Number of figures/tables/illustrations	1
Format	both print and electronic
Are you the author of this Elsevier article?	No
Will you be translating?	No
Original figure numbers	figure 2
Title of your thesis/dissertation	In Vivo Mechanical and Physical Property Changes in Highly Cross-Linked Polyethylene Acetabular Liners
Expected completion date	Nov 2018
Estimated size (number of pages)	100

**WOLTERS KLUWER HEALTH, INC. LICENSE
TERMS AND CONDITIONS**

Jun 17, 2018

This Agreement between Dr. Michael Decker ("You") and Wolters Kluwer Health, Inc. ("Wolters Kluwer Health, Inc.") consists of your license details and the terms and conditions provided by Wolters Kluwer Health, Inc. and Copyright Clearance Center.

License Number	4371621337309
License date	Jun 17, 2018
Licensed Content Publisher	Wolters Kluwer Health, Inc.
Licensed Content Publication	Journal of Bone & Joint Surgery
Licensed Content Title	Impingement with Total Hip Replacement
Licensed Content Author	Aamer Malik, Aditya Maheshwari, and Lawrence Dorr
Licensed Content Date	Aug 1, 2007
Licensed Content Volume	89
Licensed Content Issue	8
Type of Use	Dissertation/Thesis
Requestor type	Individual
STM publisher name	
Portion	Figures/table/illustration
Number of figures/tables/illustrations	1
Figures/tables/illustrations used	figure 2-A
Author of this Wolters Kluwer article	No
Title of your thesis / dissertation	In Vivo Mechanical and Physical Property Changes in Highly Cross-Linked Polyethylene Acetabular Liners
Expected completion date	Nov 2018
Estimated size(pages)	100

**ELSEVIER LICENSE
TERMS AND CONDITIONS**

Jun 17, 2018

This Agreement between Dr. Michael Decker ("You") and Elsevier ("Elsevier") consists of your license details and the terms and conditions provided by Elsevier and Copyright Clearance Center.

License Number	4371521438167
License date	Jun 17, 2018
Licensed Content Publisher	Elsevier
Licensed Content Publication	The Journal of Arthroplasty
Licensed Content Title	In Vivo Oxidative Stability Changes of Highly Cross-Linked Polyethylene Bearings: An Ex Vivo Investigation
Licensed Content Author	Shannon L. Rowell, Christopher R. Reyes, Henrik Malchau, Orhun K. Muratoglu
Licensed Content Date	Oct 1, 2015
Licensed Content Volume	30
Licensed Content Issue	10
Licensed Content Pages	7
Start Page	1828
End Page	1834
Type of Use	reuse in a thesis/dissertation
Intended publisher of new work	other
Portion	figures/tables/illustrations
Number of figures/tables/illustrations	1
Format	both print and electronic
Are you the author of this Elsevier article?	No
Will you be translating?	No
Original figure numbers	Figure 2
Title of your thesis/dissertation	In Vivo Mechanical and Physical Property Changes in Highly Cross-Linked Polyethylene Acetabular Liners
Expected completion date	Nov 2018
Estimated size (number of pages)	100

**ELSEVIER LICENSE
TERMS AND CONDITIONS**

Jun 17, 2018

This Agreement between Dr. Michael Decker ("You") and Elsevier ("Elsevier") consists of your license details and the terms and conditions provided by Elsevier and Copyright Clearance Center.

License Number	4371520697193
License date	Jun 17, 2018
Licensed Content Publisher	Elsevier
Licensed Content Publication	Journal of the Mechanical Behavior of Biomedical Materials
Licensed Content Title	Late failure of annealed highly cross-linked polyethylene acetabular liner
Licensed Content Author	Daisuke Hara, Yasuharu Nakashima, Takuaki Yamamoto, Shinshichiro Higashihara, Mitsugu Todo, Masanobu Hirata, Mio Akiyama, Yukihide Iwamoto
Licensed Content Date	Dec 1, 2013
Licensed Content Volume	28
Licensed Content Issue	n/a
Licensed Content Pages	7
Start Page	206
End Page	212
Type of Use	reuse in a thesis/dissertation
Intended publisher of new work	other
Portion	figures/tables/illustrations
Number of figures/tables/illustrations	1
Format	both print and electronic
Are you the author of this Elsevier article?	No
Will you be translating?	No
Original figure numbers	figure 2
Title of your thesis/dissertation	In Vivo Mechanical and Physical Property Changes in Highly Cross-Linked Polyethylene Acetabular Liners
Expected completion date	Nov 2018
Estimated size (number of pages)	100

**WOLTERS KLUWER HEALTH, INC. LICENSE
TERMS AND CONDITIONS**

Jun 17, 2018

This Agreement between Dr. Michael Decker ("You") and Wolters Kluwer Health, Inc. ("Wolters Kluwer Health, Inc.") consists of your license details and the terms and conditions provided by Wolters Kluwer Health, Inc. and Copyright Clearance Center.

License Number	4371520338542
License date	Jun 17, 2018
Licensed Content Publisher	Wolters Kluwer Health, Inc.
Licensed Content Publication	Journal of Bone & Joint Surgery
Licensed Content Title	Early Failure of a Cross-Linked Polyethylene Acetabular Liner: A Case Report.
Licensed Content Author	Moore, K.; Beck, Preston; Petersen, Donald; Cuckler, John; Lemons, Jack; Eberhardt, Alan
Licensed Content Date	Nov 1, 2008
Licensed Content Volume	90
Licensed Content Issue	11
Type of Use	Dissertation/Thesis
Requestor type	Individual
STM publisher name	
Portion	Figures/table/illustration
Number of figures/tables/illustrations	1
Figures/tables/illustrations used	Figure 2
Author of this Wolters Kluwer article	No
Title of your thesis / dissertation	In Vivo Mechanical and Physical Property Changes in Highly Cross-Linked Polyethylene Acetabular Liners
Expected completion date	Nov 2018
Estimated size(pages)	100

**ELSEVIER LICENSE
TERMS AND CONDITIONS**

Jun 17, 2018

This Agreement between Dr. Michael Decker ("You") and Elsevier ("Elsevier") consists of your license details and the terms and conditions provided by Elsevier and Copyright Clearance Center.

License Number	4371510582836
License date	Jun 17, 2018
Licensed Content Publisher	Elsevier
Licensed Content Publication	Elsevier Books
Licensed Content Title	UHMWPE Biomaterials Handbook
Licensed Content Author	Luigi Costa,Pierangiola Bracco
Licensed Content Date	Jan 1, 2016
Licensed Content Pages	21
Start Page	467
End Page	487
Type of Use	reuse in a thesis/dissertation
Intended publisher of new work	other
Portion	figures/tables/illustrations
Number of figures/tables/illustrations	1
Format	both print and electronic
Are you the author of this Elsevier chapter?	No
Will you be translating?	No
Original figure numbers	scheme 26.7
Title of your thesis/dissertation	In Vivo Mechanical and Physical Property Changes in Highly Cross-Linked Polyethylene Acetabular Liners
Expected completion date	Nov 2018
Estimated size (number of pages)	100

**ELSEVIER LICENSE
TERMS AND CONDITIONS**

Jun 17, 2018

This Agreement between Dr. Michael Decker ("You") and Elsevier ("Elsevier") consists of your license details and the terms and conditions provided by Elsevier and Copyright Clearance Center.

License Number	4371500971002
License date	Jun 17, 2018
Licensed Content Publisher	Elsevier
Licensed Content Publication	Acta Biomaterialia
Licensed Content Title	Raman spectroscopy of biomedical polyethylenes
Licensed Content Author	Giuseppe Pezzotti
Licensed Content Date	Jun 1, 2017
Licensed Content Volume	55
Licensed Content Issue	n/a
Licensed Content Pages	72
Start Page	28
End Page	99
Type of Use	reuse in a thesis/dissertation
Portion	figures/tables/illustrations
Number of figures/tables/illustrations	1
Format	both print and electronic
Are you the author of this Elsevier article?	No
Will you be translating?	No
Original figure numbers	figure 1 (a)
Title of your thesis/dissertation	In Vivo Mechanical and Physical Property Changes in Highly Cross-Linked Polyethylene Acetabular Liners
Expected completion date	Nov 2018
Estimated size (number of pages)	100

[Register](#) | [Member Portal](#)

[Advanced search](#)
[What We Do](#) [Capabilities](#) [Industries](#) [Membership](#) [Technical Knowledge](#) [News and Events](#) [About Us](#) [Contact Us](#)
[Home](#) > [Terms and Conditions](#)

 Share: [f](#) [t](#) [in](#) [s](#) [e](#) [m](#)

Terms and Conditions

Copyright Notice

Except where otherwise stated, copyright of all materials resides with the TWI Ltd. No material may be altered to any degree without TWI Ltd's written consent.

Legal Notice

The information made available by TWI Ltd over the World Wide Web does not form part of any contract. Changing circumstances may cause TWI Ltd to have to change its provisions at any time. Whilst every effort has been made to ensure the accuracy of the information presented, TWI Ltd cannot accept responsibility for errors.

The content of this website is for information purposes only. The information is provided by TWI Ltd and whilst we endeavour to keep the information up-to-date and correct, we make no representations or warranties of any kind, express or implied, about the completeness, accuracy, reliability or suitability of the information, products, services, or related graphics contained on the website for any purpose. Any reliance you place on such information is therefore strictly at your own risk.

Through this website you are able to link to other websites which are not under the control of TWI Ltd. We have no control over the nature, content and availability of those sites. The inclusion of any links does not necessarily imply a recommendation or endorse the views expressed within them.

Every effort is made to keep the website up and running. However, TWI Ltd accepts no responsibility for and will not be liable for the website being unavailable due to technical issues.

Junk mail

No email addresses obtained from this site may be used for unsolicited mailings (junk mail).

Permissions for using images from our website

Permission for use of photographic imagery from this website is granted only under the following conditions:

- † Each use should be accompanied by the credit line and notice, "**Courtesy of TWI Ltd**".
- † Copying of images for further distribution or commercial use is prohibited without the express written consent of TWI.
- † No permission is granted to use trademarks of TWI Ltd, its subsidiaries or affiliates, apart from the incidental appearance of such trademarks in the photograph(s)/imagery provided by TWI.
- † TWI reserves the right to withdraw permission to reproduce copyright material whenever, in its discretion, it feels that the privilege of reproducing its material is being used in a way detrimental to its interest or the above instructions are not being followed properly to protect its copyright.
- † This permission is provided without warranty of any kind, either expressed or implied, including but not limited to implied warranties of merchantability and fitness for a particular purpose.

Hip Pelvis. 2014 Jun;26(2):65-73. English.
Published online June 30, 2014. <https://doi.org/10.5371/hp.2014.26.2.65>

Copyright © 2014 by Korean Hip Society

Arthroplasty in Femoral Head Osteonecrosis

Yoon Je Cho, MD,  Dong Cheol Nam, MD and Kwangyoung Jung, MD

Department of Orthopedic Surgery, Kyung Hee University School of Medicine, Seoul, Korea.

 Address reprint request to Yoon Je Cho, MD. Department of Orthopedic Surgery, Kyung Hee University Medical Center, 23 Kyungheedaero, Dongdaemun-gu, Seoul 130-872, Korea. TEL: +82-2-958-8372, FAX: +82-2-958-8346, Email: yjcho@khmc.or.kr

Received January 29, 2014; Revised February 26, 2014; Accepted March 17, 2014.

This is an Open Access article distributed under the terms of the Creative Commons Attribution Non-Commercial License (<http://creativecommons.org/licenses/by-nc/3.0/>) which permits unrestricted non-commercial use, distribution, and reproduction in any medium, provided the original work is properly cited.

▼ Cite this page

. Total Hip Arthroplasty (THA). *OrthopaedicsOne Clerkship. In: OrthopaedicsOne - The Orthopaedic Knowledge Network*. Created Dec 13, 2010 21:12. Last modified Dec 14, 2010 09:10 ver.3. Retrieved 2018-08-27, from <https://www.orthopaedicsone.com/xl-oDYAg>.

▶ Page contributions

▶ Page metrics



FIND A SPECIALIST | ORTHOGATE.ORG
Find an orthopaedic surgeon or allied health professional near you



All site content, except where otherwise noted, is licensed under a Creative Commons Attribution-NonCommercial-Share Alike 3.0 License

Journal List > Open Orthop J > v.4; 2010 > PMC2892068

BENTHAM OPEN

The Open Orthopaedics Journal

Open Orthop J. 2010; 4: 169–180.

Published online 2010 May 11. doi: [10.2174/1874325001004010169](https://doi.org/10.2174/1874325001004010169)

PMCID: PMC2892068

PMID: [20582240](https://pubmed.ncbi.nlm.nih.gov/20582240/)

Basic Science Considerations in Primary Total Hip Replacement Arthroplasty

Saqeb B Mirza,¹ Douglas G Dunlop,² Sukhmeet S Panesar,³ Syed G Naqvi,⁴ Shafat Gangoo,⁵ and Saif Salih⁶

Author information ▶ Article notes ▶ Copyright and License information ▼ Disclaimer

Copyright © Mirza et al.; licensee Bentham Open.

This is an open access article licensed under the terms of the Creative Commons Attribution Non-Commercial License (<http://creativecommons.org/licenses/by-nc/3.0/>) which permits unrestricted, non-commercial use, distribution and reproduction in any medium, provided the work is properly cited.

Curriculum Vitae

Name: Michael Decker, MD

Professional Work History

2018 Assistant Professor
 The University of New Mexico School of Medicine, Department of
 Orthopaedic Surgery, Division of Adult Reconstruction

Education

2017-2018 **The University of Western Ontario**, Masters of Science (MSc) in Surgery,
 Anticipated Completion October 2018
 2008-2012 **The University of Illinois at Chicago College of Medicine**, Medical
 Doctor, May 2012
 2003-2007 **Boston University**, B.S. Human Physiology, *Cum Laude*, May 2007

Post Graduate Education

2017-2018 **The University of Western Ontario**, London, ON, CA
 Adult Reconstruction Fellowship, Completed July 31, 2018
 2012-2017 **The University of New Mexico School of Medicine**, Albuquerque, NM
 Orthopedic Surgery Residency Program, Completed June 30, 2017

Medical Licensure and Certification

2015 State of New Mexico Medical License MD2015-0098, Active
 2013 USMLE Step 3
 2011 USMLE Step 2 CK
 2011 USMLE Step 2 CS
 2010 USMLE Step 1

Professional Society Memberships

2018 American Association of Hip and Knee Surgeons, Member
 2016 The American Orthopaedic Association, Emerging Leaders Membership
 2012 The American Academy of Orthopaedic Surgeons, Resident Member

Honors and Awards

Residency

- 2016 American Orthopaedic Association Resident Leadership Forum Nominee and Participant
- 2015 Outstanding Resident Research Award, UNM Department of Orthopaedic Surgery

Medical School

- 2010-2011 President, Chicago Medical Student Council
- 2009-2010 Expanded Leadership Certification, two years of participation in the Chicago Medical Student Council Leadership Certification Program
- 2009 Abbas Hyderi Leadership Award for Outstanding Student Leadership and Advocacy
- 2009 Selected Student Head of University of Illinois at Chicago student/faculty curriculum committee, Chicago Medical Student Council
- 2008 Selected Student Voting Member, University of Illinois at Chicago student/faculty curriculum committee, Chicago Medical Student Council

Undergraduate

- 2007 Graduated Cum Laude in Human Physiology
- 2006 Recipient of Boston University Undergraduate Research Opportunities Program (UROP) Research Grant

Certificates and Courses

- 2016 Residents as Educators Program, University of New Mexico
- 2016 American Orthopaedic Association Resident Leadership Forum
- 2016 Stryker Triathlon Primary & Revision Knee Surgical Training Course Participant
- 2016 Stryker Direct Anterior Approach to the Hip Surgical Training Course Participant
- 2015 Arthrex Knee and Shoulder Arthroscopy Course Participant
- 2014 AO Trauma Basic Principles in Fracture Management Course Participant
- 2013 Arthrex Knee and Shoulder Arthroscopy Course Participant
- 2013 Arthrex Knee and Shoulder Arthroscopy Course Participant
- Southwestern Orthopedic Trauma Association Course Participant

Publications

Peer Reviewed Publications

1. **Decker M.** Value-Based Bundled Repayment in Total Joint Arthroplasty. The University of New Mexico Orthopaedics Research Journal. 2017; 6:7-11
2. Bennett D, Koehler L, Margolis D, Radelet M, Lu Z, Pedri T, **Decker M**, Miller M. Technique of Fixation of Femoral Stems used in Total Hip Arthroplasty for Predicting Vancouver Types B1 and B2 Periprosthetic Fractures of the Femur: A

- Systematic Review. The University of New Mexico Orthopaedics Research Journal. 2016; 5:36-39
3. **Decker M**, Strohmeier G, Wood J, Hatch G, Qualls C, Treme G, Benson EC. Distal Tibia Allograft for Glenohumeral Instability: Does Radius of Curvature Match? J Shoulder Elbow Surg. 2016 Apr 7. pii: S1058-2746(16)00061-6. doi: 10.1016/j.jse.2016.01.023
 4. Miskimins RJ, **Decker M**, Hobby BD, Howdieshell TR, Lu SW, West SD. Complications of Pelvic Ring Fixation in Patients Requiring Laparotomy. Journal of Surgical Research, 2015. 2015 Jun 3 (accepted for ePub ahead of print). DOI:10.1016/j.jss.2015.05.051
 5. Elenes S, **Decker M**, Cymes GD, Grosman C. Decremental response to high-frequency trains of acetylcholine pulses but unaltered fractional Ca²⁺ currents in a panel of "slow-channel syndrome" nicotinic receptor mutants. Journal of General Physiology. 2009 Feb;133(2):151-69. DOI: 10.1085/jgp.200810089

Abstracts, Poster Presentations, Proceedings and Reviews

1. **Decker, M**. Preparing Residents for Health Care Reform. The University of New Mexico Orthopaedics Research Journal. 2017; 6:170-71
2. **Decker, M**. Left Behind: Why Excluding Residents from Delivery System Reform Hurts Us All. Wing of Zock, 10/30/2015. <http://wingofzock.org/2015/10/30/left-behind-why-excluding-residents-from-delivery-system-reform-hurts-us-all>
3. **Decker M**, Strohmeier G, Wood J, Hatch G, Qualls C, Treme G, Benson EC. Distal Tibia Radius of Curvature: Does It Match Shoulder Anatomy? Abstract and Podium Presentation, Western Orthopaedic Association Annual Meeting July 2015.
4. Clifton B, Richter D, Tandberg D, Furgeson M, Treme G. Evaluation of the Tibial Tubercle to Posterior Cruciate Ligament Distance in a Pediatric Patient Population. Podium Presentation, Western Orthopaedic Association Annual Meeting July 2015.
5. Miskimins R, **Decker M**, Howdieshell TR, Lu SW, West SD. Complications Associated with Pelvic Fixation Methods in Combined Pelvic and Abdominal Trauma. Abstract and Podium Presentation, Academic Surgical Conference February 2015.
6. **Decker M**, Shen L, Yao D, Liou L. Differential Expression of Vitamin D Receptor Observed in Clear Cell Renal Cell Carcinoma. Poster Presentation, Boston University Undergraduate Research Opportunity Program, 2006.

Meeting Presentations and Grand Rounds

1. **Decker M**. From Volume to Value: Delivery Reform in Total Joint Replacement. Grand Rounds Presentation, November 2016. University of New Mexico Health Science Center Department of Orthopaedics and Rehabilitation, Albuquerque, NM, USA.

2. **Decker M.** Moriates C, Walradt J. Engaging the Next Generation of Clinicians in Delivery Reform. Meeting Presentation, November 2016. Learn Serve Lead 2016: The AAMC Annual Meeting, Seattle, WA, USA.
3. **Decker M.** Walradt J. Follow the Money! How Payment Reform is Changing Care Delivery. Meeting Presentation, June 2016. AAMC Integrating Quality Meeting, Chicago, IL, USA.
4. **Decker M.** Intraoperative Fractures in Elective Total Joint Arthroplasty. Grand Rounds Presentation, March 2016. New Mexico Veterans Affairs Health Care System, Albuquerque, NM, USA.
5. **Decker M.** Taper Trouble in Total Hip Arthroplasty. Grand Rounds Presentation, May 2016. University of New Mexico Health Science Center Department of Orthopaedics and Rehabilitation, Albuquerque, NM, USA.